

# 28

Страницы раздела  
001-076

## КОСТНАЯ ХИРУРГИЯ BONE SURGERY

Перейти в [СОДЕРЖАНИЕ](#)





28.0010.08 8mm  
28.0010.10 10mm  
28.0010.12 12mm  
28.0010.14 14mm  
28.0010.16 16mm  
13.5cm



28.0012.08 8mm  
28.0012.10 10mm  
28.0012.12 12mm  
28.0012.14 14mm  
28.0012.16 16mm  
13.5cm



28.0014.08 8mm  
28.0014.10 10mm  
28.0014.12 12mm  
28.0014.14 14mm  
28.0014.16 16mm  
13.5cm



**PARTSCH**

13.5cm 17.0cm  
28.0020.02 2mm 28.0022.02  
28.0020.03 3mm 28.0022.03  
28.0020.04 4mm 28.0022.04  
28.0020.05 5mm 28.0022.05  
28.0020.06 6mm 28.0022.06



**PARTSCH**

13.5cm 17.0cm  
28.0024.02 2mm 28.0026.02  
28.0024.03 3mm 28.0026.03  
28.0024.04 4mm 28.0026.04  
28.0024.05 5mm 28.0026.05  
28.0024.06 6mm 28.0026.06

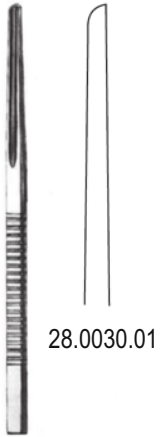

28.0030.01

**BUCK-GRAMCKO**  
11.0cm

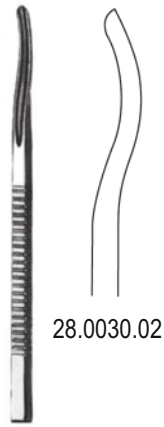

28.0030.02

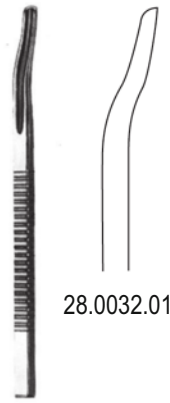

28.0032.01

**BUCK-GRAMCKO**  
10.0cm

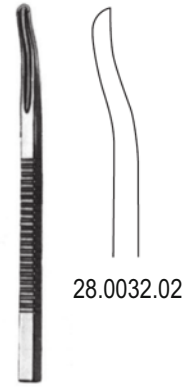

28.0032.02

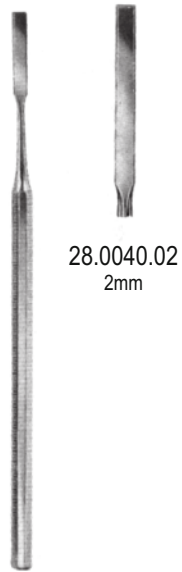

28.0040.02  
2mm

**BUCKLEY**  
16.0cm



28.0040.03  
3mm

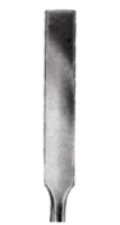

28.0040.04  
4mm



28.0042.02  
2mm

**BUCKLEY**  
16.0cm



28.0042.03  
3mm



28.0042.04  
4mm



**ALEXANDER**  
18.0cm

28.0046.04 04mm  
28.0046.06 06mm  
28.0046.08 08mm  
28.0046.10 10mm  
28.0046.12 12mm  
28.0046.14 14mm



**ALEXANDER**  
18.0cm

28.0048.04 04mm  
28.0048.06 06mm  
28.0048.08 08mm  
28.0048.10 10mm  
28.0048.12 12mm  
28.0048.14 14mm



**STILLE**  
20.0cm

28.0050.10 10mm  
28.0050.15 15mm  
28.0050.20 20mm  
28.0050.25 25mm



**STILLE**  
20.0cm

28.0052.10 10mm  
28.0052.15 15mm  
28.0052.20 20mm  
28.0052.25 25mm



**STILLE**  
20.0cm

28.0054.10 10mm  
28.0054.15 15mm  
28.0054.20 20mm  
28.0054.25 25mm





- 28.0060.06 6mm
- 28.0060.09 9mm
- 28.0060.13 13mm
- 28.0060.16 16mm
- 28.0060.19 19mm
- 28.0060.25 25mm
- 28.0060.32 32mm

SMITH-PETERSEN  
20.0cm



- 28.0061.06 6mm
- 28.0061.09 9mm
- 28.0061.13 13mm
- 28.0061.16 16mm
- 28.0061.19 19mm
- 28.0061.25 25mm
- 28.0061.32 32mm

SMITH-PETERSEN  
20.0cm



- 28.0064.06 6mm
- 28.0064.09 9mm
- 28.0064.13 13mm
- 28.0064.16 16mm
- 28.0064.19 19mm
- 28.0064.25 25mm
- 28.0064.32 32mm

SMITH-PETERSEN  
20.0cm



- 28.0065.06 6mm
- 28.0065.09 9mm
- 28.0065.13 13mm
- 28.0065.16 16mm
- 28.0065.19 19mm
- 28.0065.25 25mm
- 28.0065.32 32mm

SMITH-PETERSEN  
20.0cm



- 28.0070.03 3mm
- 28.0070.05 5mm
- 28.0070.06 6mm
- 28.0070.08 8mm
- 28.0070.09 9mm

**НОКЕ**  
17.0cm



- 28.0080.06 6mm
- 28.0080.13 13mm
- 28.0080.19 19mm
- 28.0080.25 25mm
- 28.0080.32 32mm

**HIBBS**  
24.0cm



- 28.0084.06 6mm
- 28.0084.13 13mm
- 28.0084.19 19mm
- 28.0084.25 25mm
- 28.0084.32 32mm

**HIBBS**  
24.0cm



- 28.0081.06 6mm
- 28.0081.13 13mm
- 28.0081.19 19mm
- 28.0081.25 25mm
- 28.0081.32 32mm

**HIBBS**  
24.0cm



- 28.0086.06 6mm
- 28.0086.13 13mm
- 28.0086.19 19mm
- 28.0086.25 25mm
- 28.0086.32 32mm

**HIBBS**  
24.0cm



- 28.0087.06 6mm
- 28.0087.13 13mm
- 28.0087.19 19mm
- 28.0087.25 25mm
- 28.0087.32 32mm

**HIBBS**  
24.0cm



- 28.0090.03 3mm
- 28.0090.04 4mm
- 28.0090.06 6mm
- 28.0090.08 8mm
- 28.0090.10 10mm
- 28.0090.12 12mm
- 28.0090.15 15mm

**MINI-LAMBOTTE**  
12.5cm



- 28.0092.03 3mm
- 28.0092.04 4mm
- 28.0092.06 6mm
- 28.0092.08 8mm
- 28.0092.10 10mm
- 28.0092.12 12mm
- 28.0092.15 15mm

**MINI-LAMBOTTE**  
17.0cm



- 28.0094.15 15mm
- 28.0094.20 20mm
- 28.0094.25 25mm
- 28.0094.30 30mm
- 28.0094.38 38mm
- 28.0094.44 44mm
- 28.0094.50 50mm

**LAMBOTTE**  
24.0cm



- 28.0095.15 15mm
- 28.0095.20 20mm
- 28.0095.25 25mm
- 28.0095.30 30mm
- 28.0095.38 38mm
- 28.0095.44 44mm
- 28.0095.50 50mm

**LAMBOTTE**  
23.0cm



28.0100.04 4mm  
28.0100.06 6mm  
28.0100.08 8mm  
28.0100.10 10mm  
28.0100.12 12mm

**MINI-LEXER**  
18.0cm



28.0102.04 4mm  
28.0102.06 6mm  
28.0102.08 8mm  
28.0102.10 10mm  
28.0102.12 12mm

**MINI-LEXER**  
18.0cm

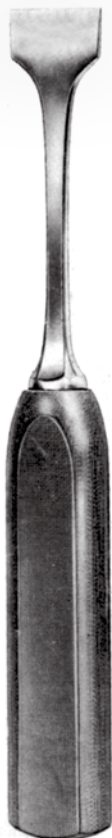

28.0104.07 7mm  
28.0104.10 10mm  
28.0104.15 15mm  
28.0104.20 20mm  
28.0104.25 25mm  
28.0104.30 30mm

**LEXER**  
22.0cm



28.0106.07 7mm  
28.0106.10 10mm  
28.0106.15 15mm  
28.0106.20 20mm  
28.0106.25 25mm  
28.0106.30 30mm

**LEXER**  
22.0cm



28.0110.05 5mm  
28.0110.10 10mm  
28.0110.15 15mm

**LEXER**  
25.0cm



28.0111.05 5mm  
28.0111.10 10mm  
28.0111.15 15mm

**LEXER**  
25.0cm



**MEAD**  
28.0120.17 17.0cm  
26mm Ø,320 g (11¼ oz)



**PARTSCH**  
28.0124.18 18.0cm  
22mm Ø,200 g (7 oz)

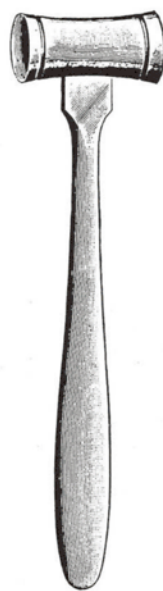

28.0130.30  
30mm Ø,510 g

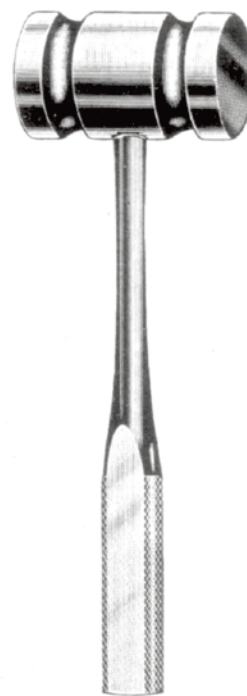

28.0134.25 250 g  
28.0134.45 450 g  
28.0134.90 900 g  
26.5cm

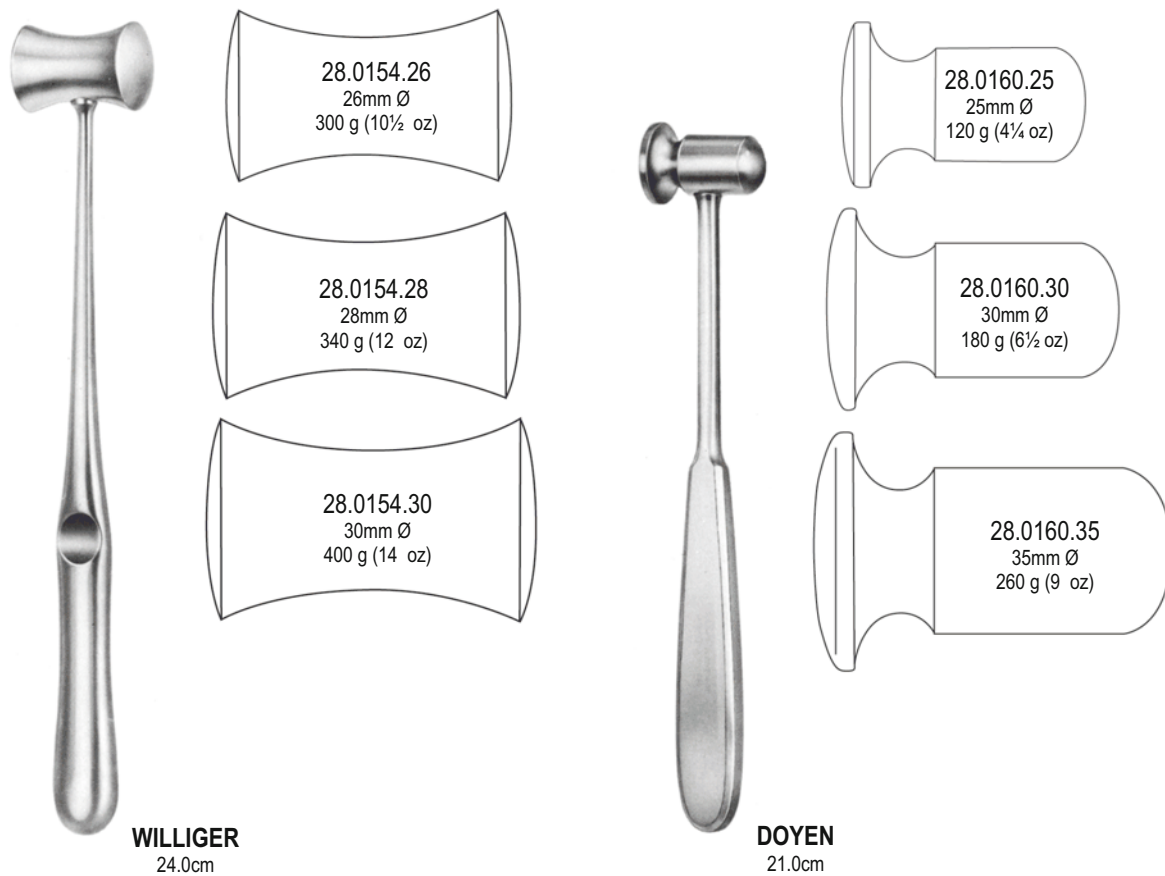
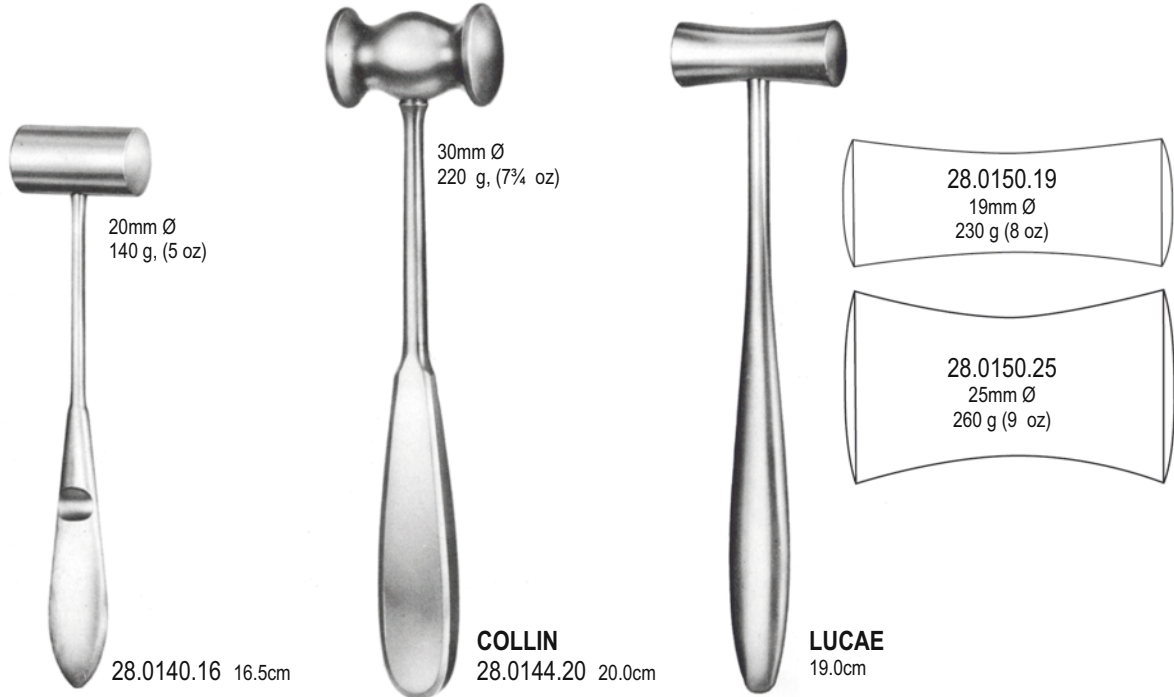

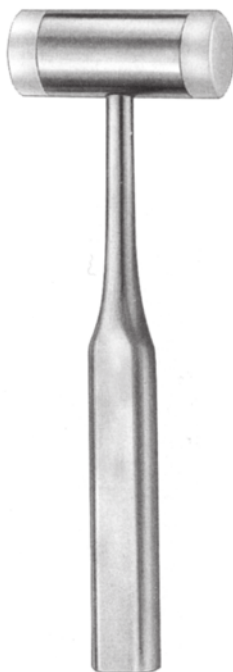

28.0164.18 18.5cm  
25mm Ø 135 g



lead filled

28.0170.19 19.0cm  
22mm Ø 155 g



**HAJEK**  
28.0174.22 22.0cm  
27mm Ø 130 g

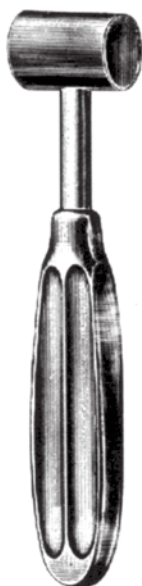

**GERZOG**  
28.0180.18 18.0cm  
250 g

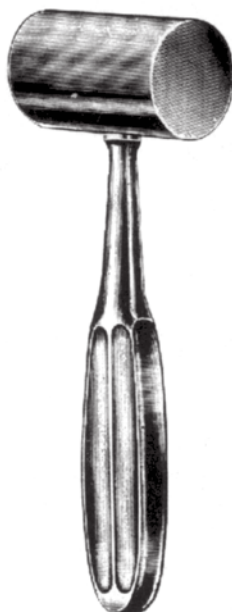

**KIRK**  
28.0184.19 19.0cm  
750 g

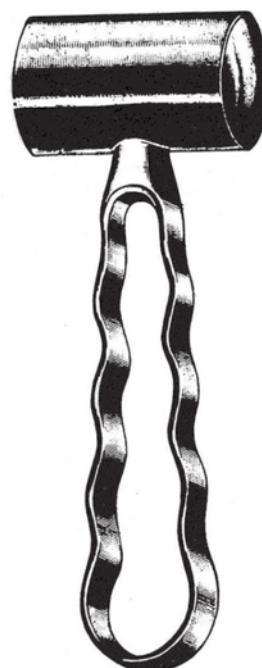

**HEATH**  
18.0cm  
28.0188.35 35mm Ø (28 oz)  
28.0188.40 40mm Ø (36 oz)



28.0200.00  
spare faces



28.0190.26  
26.5cm 530 g (19 oz)



28.0194.24  
24.0cm (30mm Ø 480 g)



28.0200.22  
22.5cm (37mm Ø 370 g)



28.0204.24 24.0cm



28.0210.26 26.5cm  
30mm Ø, 510 g (18 oz)



28.0214.26 26.5cm



28.0220.25 26.5cm 250 g (0.55 lbs)  
28.0220.45 26.5cm 450 g (1 lbs)  
28.0220.90 26.5cm 900 g (2 lbs)



**WILLIGER**  
17.5cm

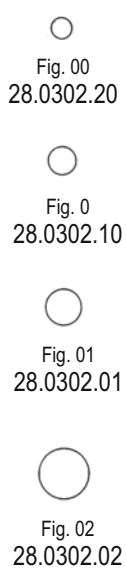

**BRUNS**  
23.0cm



**SIMON**  
24.0cm

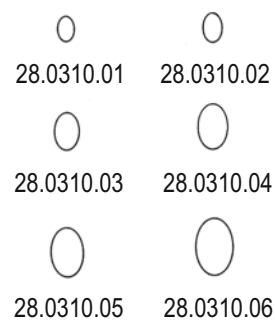



**MOD. USA**  
16.0cm

Fig.1

Fig.2

Fig.03

Fig.04

Fig.05

Fig.06

- Fig.1 28.0320.01
- Fig.2 28.0320.02
- Fig.3 28.0320.03
- Fig.4 28.0320.04
- Fig.5 28.0320.05
- Fig.6 28.0320.06

- 28.0322.01
- 28.0322.02
- 28.0322.03
- 28.0322.04
- 28.0322.05
- 28.0322.06

- 28.0324.01
- 28.0324.02
- 28.0324.03
- 28.0324.04
- 28.0324.05
- 28.0324.06



**LEMPERT**  
17.5cm

Fig.0

Fig.00

Fig.000

Fig.0000

Fig.00000

- Fig.0 28.0330.10
- Fig.00 28.0330.20
- Fig.000 28.0330.30
- Fig.0000 28.0330.40
- Fig.00000 28.0330.50



**HALLE**  
21.0cm

28.0334.01

28.0334.02

28.0334.03



25.0cm











28.0340.01

28.0340.02

28.0340.03













**VOLKMANN**  
17.0cm

 0000 28.0344.40	 000 28.0344.30	 00 28.0344.20
 0 28.0344.10	 1 28.0344.01	 2 28.0344.02
	 3 28.0344.03	 4 28.0344.04
	 5 28.0344.05	 6 28.0344.06









**BRUNS**  
17.0cm

 0000 28.0350.40	 000 28.0350.30	 00 28.0350.20
 0 28.0350.10	 1 28.0350.01	 2 28.0350.02
	 3 28.0350.03	 4 28.0350.04
	 5 28.0350.05	 6 28.0350.06











**SCHEDE**  
17.0cm

 000 28.0354.30	 00 28.0354.20	 0 28.0354.10
	 1 28.0354.01	 2 28.0354.02
	 3 28.0354.03	 4 28.0354.04



**SPRATT**  
16.5cm

 0000 28.0360.40	 000 28.0360.30	 00 28.0360.20
 0 28.0360.10		 1 28.0360.01
 2 28.0360.02		 3 28.0360.03
 4 28.0360.04		 5 28.0360.05

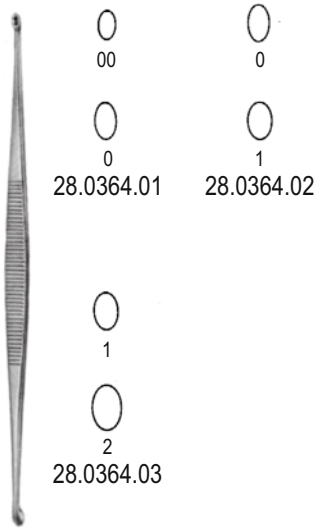

28.0364.01

28.0364.02

28.0364.03

**WILLIGER**  
13.5cm

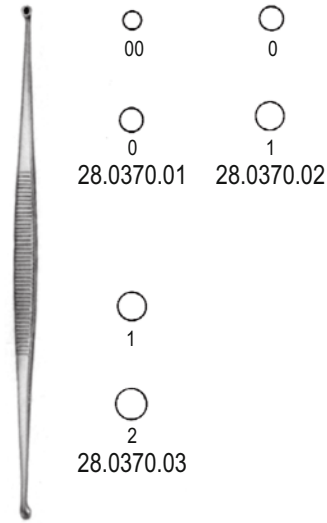

28.0370.01

28.0370.02

28.0370.03

**MARTINI**  
13.5cm



**VOLKMANN**  
28.0374.13 13.0cm  
28.0374.14 14.0cm  
28.0374.17 17.0cm



**VOLKMANN**  
28.0380.13 13.0cm  
28.0380.16 16.0cm  
28.0380.20 20.0cm



28.0384.21 21.0cm

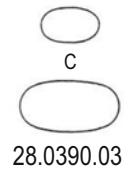
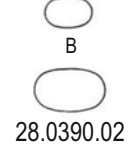
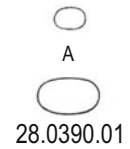

**VOLKMANN**  
21.5cm

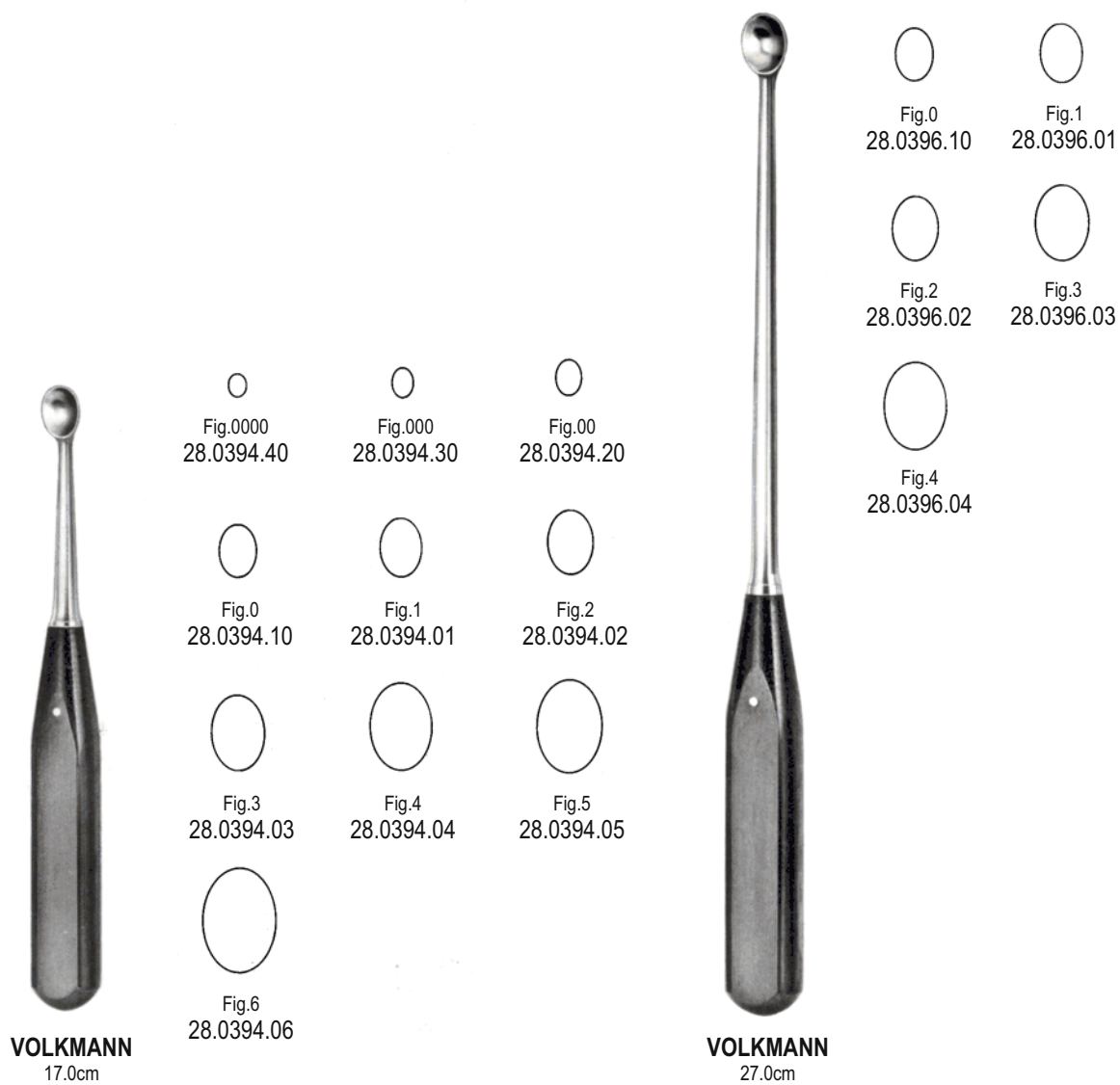



28.0400.22 22.0cm



28.0404.24 24.5cm



28.0410.28 28.0cm



**PUTTI**  
28.0414.30 30.0cm



**PUTTI**  
28.0416.27 27.0cm







MILLER  
# 10  
28.0450.10



MILLER  
# 11  
28.0450.11



MILLER  
# 12  
28.0450.12



MILLER  
# 13  
28.0450.13



MILLER  
# 14  
28.0450.14



MILLER  
# 10c  
28.0452.10



MILLER  
# 11c  
28.0452.11



MILLER  
# 12c  
28.0452.12



MILLER  
# 13c  
28.0452.13



FOMON  
21.5cm  
28.0460.21



FOMON  
21.5cm  
28.0462.21



28.0470.01  
17.5cm

28.0470.02  
21.0cm

28.0470.03  
17.5cm

28.0470.04  
21.0cm

28.0470.05  
20.5cm

28.0470.06  
20.5cm

28.0470.07  
22.5cm

SEMB

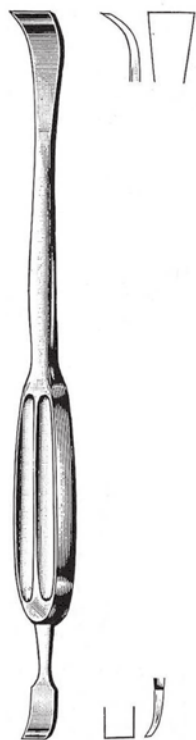

DAVIDSON-ALEXANDER  
28.0474.29 29.0cm



ALEXANDER  
28.0480.20 20.0cm

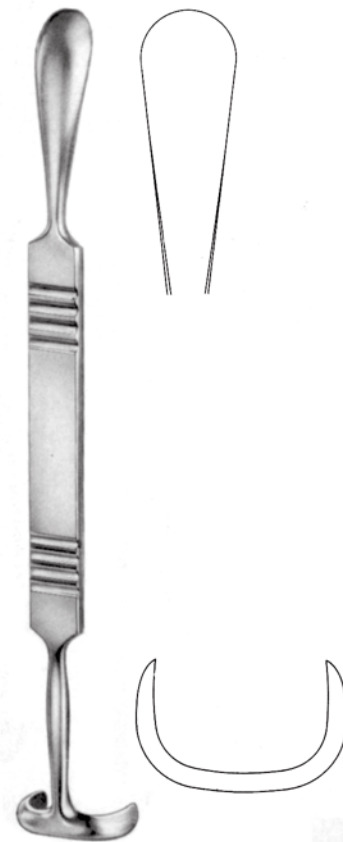

MATSON  
28.0484.22 22.0cm

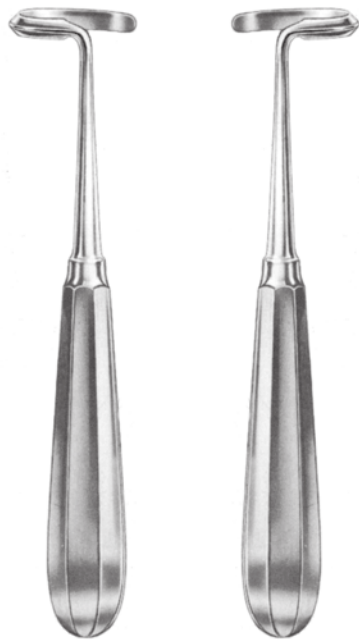

**DOYEN**  
 17.0cm



28.0490.01



28.0490.02



28.0492.01



28.0492.02

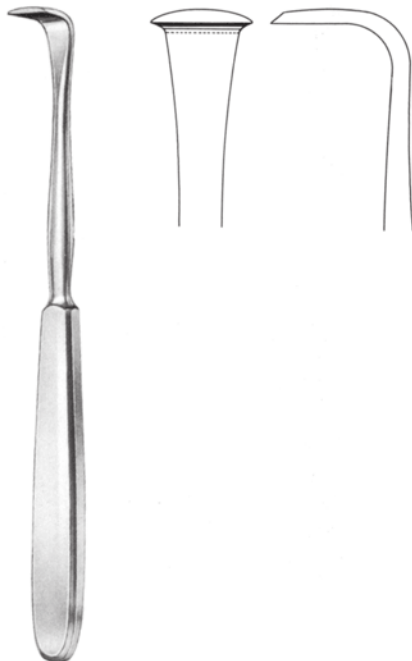

**LANGENBECK**  
 28.0500.18 18.0cm

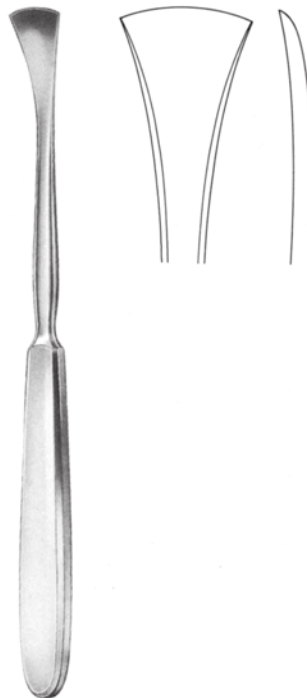

**LANGENBECK**  
 28.0502.19 19.0cm



28.0506.10 10mm  
 28.0506.15 15mm  
 28.0506.20 20mm  
 28.0506.25 25mm

**LAMBOTTE**  
 21.0cm

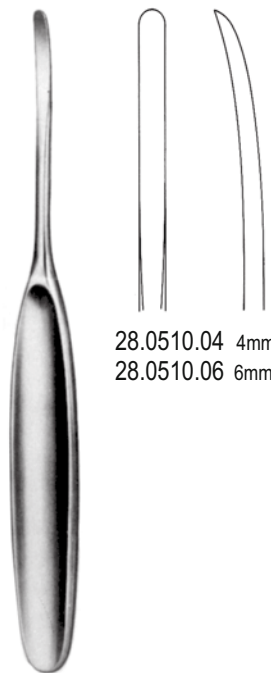

28.0510.04 4mm  
28.0510.06 6mm

**CUSHING**  
17.0cm

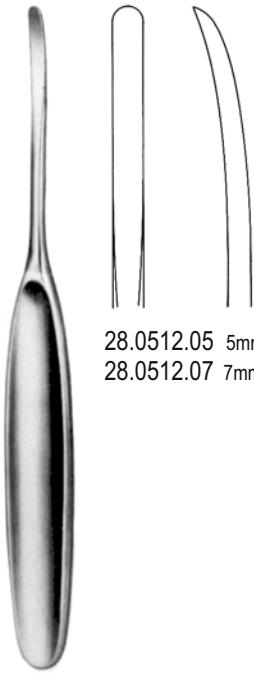

28.0512.05 5mm  
28.0512.07 7mm

**CUSHING**  
19.5cm

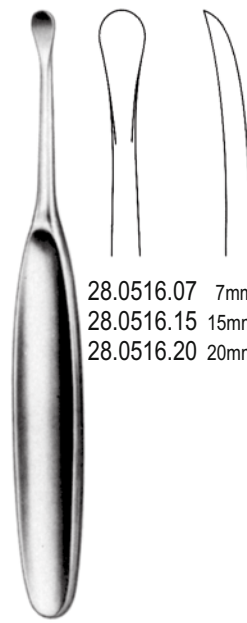

28.0516.07 7mm,16.0cm  
28.0516.15 15mm,18.5cm  
28.0516.20 20mm,19.0cm

**HOEN**

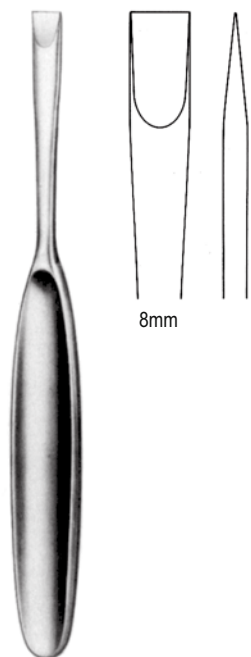

8mm

**CUSHING**  
28.0520.17  
17.0cm

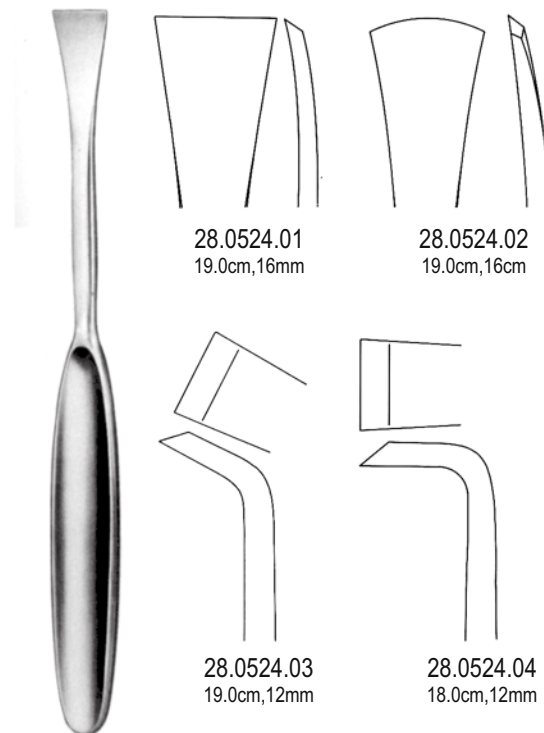

28.0524.01  
19.0cm,16mm

28.0524.02  
19.0cm,16cm

28.0524.03  
19.0cm,12mm

28.0524.04  
18.0cm,12mm

**LANGENBECK**

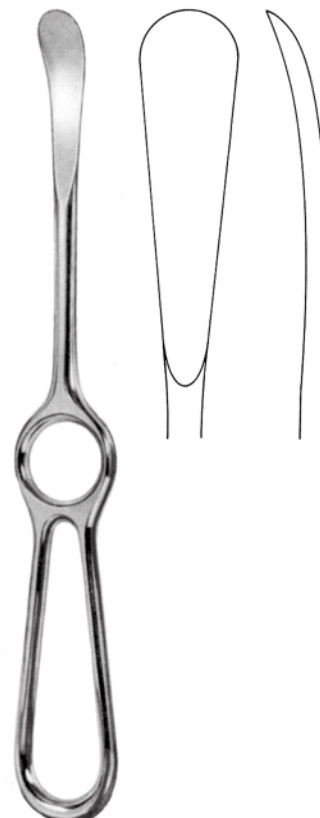

**SEDILLOT**  
28.0530.21  
21.0cm

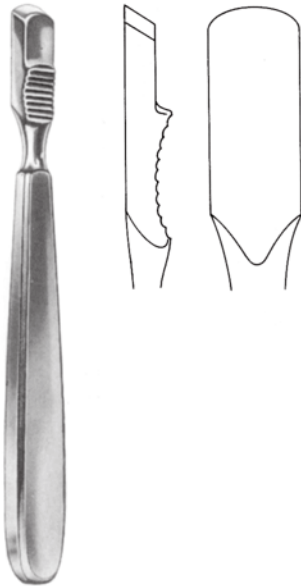

**FARABEU**  
28.0534.15 15.0cm



**FARABEU**  
28.0535.15 15.0cm



17.0cm

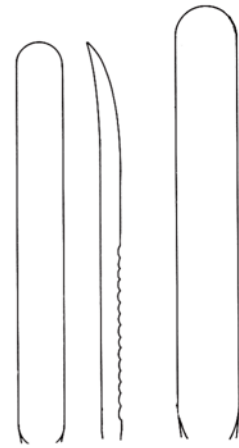

28.0540.06  
6mm

28.0540.08  
8mm

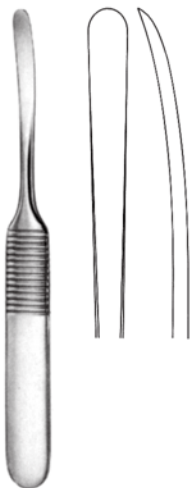

**WILLIGER**  
28.0544.13 13.0cm



**WILLIGER**  
28.0546.16 16.0cm



28.0550.05  
5mm

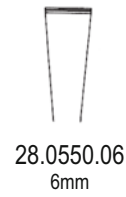

28.0550.06  
6mm



28.0550.07  
7mm



28.0554.27 27.5cm  
20mm



**WAGNER**

33.0cm  
28.0560.08 8mm  
28.0560.17 17mm



28.0564.18 18.0cm



28.0570.18 18.0cm



28.0572.18 18.0cm



28.0574.19 19.0cm

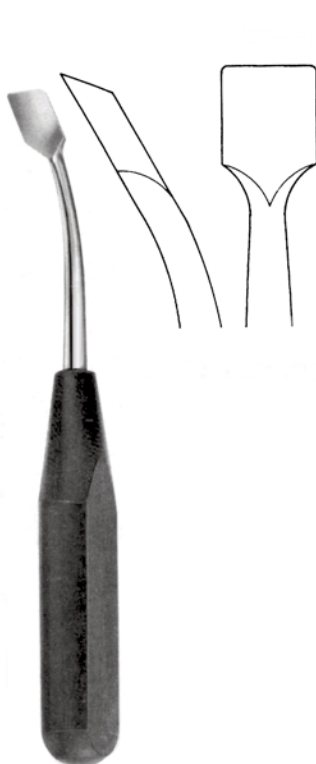

28.0576.18 18.5cm



28.0580.20 20.0cm



28.0581.20 20.0cm

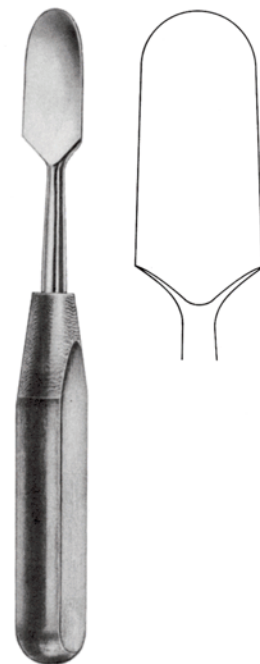

28.0584.20 20.0cm





**COBB**

24.0cm		28.0cm	
28.0590.10	10mm	28.0592.10	10mm
28.0590.13	13mm	28.0592.13	13mm
28.0590.19	19mm	28.0592.19	19mm
28.0590.25	25mm	28.0592.25	25mm
28.0590.32	32mm	28.0592.32	32mm



**COBB**

27.0cm	
28.0594.04	4mm
28.0594.06	6mm
28.0594.08	8mm



**COBB**

28.0cm	
28.0596.08	8mm
28.0596.10	10mm
28.0596.12	12mm





28.0600.16 16.0cm



28.0604.17 17.5cm

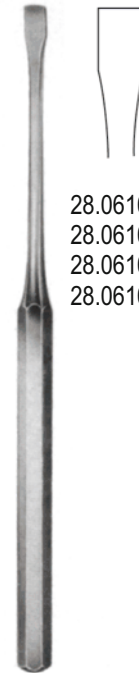

28.0610.06 6mm  
28.0610.12 12mm  
28.0610.19 19mm  
28.0610.25 25mm

KEY  
19.0cm



ALDERDYCE  
28.0614.21 21.0cm

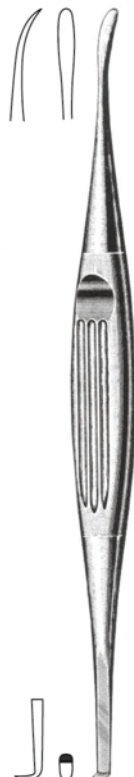

OVERHOLT  
28.0620.29 29.5cm



OVERHOLT  
28.0622.29 29.5cm



OVERHOLT  
28.0624.28 28.5cm



**LANGENBECK**  
20.0cm  
28.0630.08 8mm  
28.0630.10 10mm



**LANGENBECK**



28.0632.05  
17.0cm, 5mm



28.0632.07  
17.0cm, 7mm



28.0632.08  
20.0cm, 8mm



28.0632.10  
20.0cm, 10mm



**ST. THOMAS**  
28.0636.18 18.0cm



**ADSON**  
17.0cm

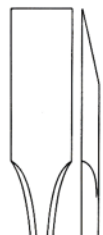

28.0640.01



28.0640.02



28.0640.03



28.0640.04



**WILLIGER**  
17.0cm



28.0644.17



**WILLIGER**  
16.0cm



28.0646.16



28.0648.16  
16.0cm





**LANE**  
28.0650.26 26.5cm



**LANE TRETOWAN**  
28.0652.21 21.5cm



**LANE**  
28.0654.25 25.5cm



**BRISTOW**  
28.0660.23 23.0cm



**MURPHY-LANE**  
28.0664.30 30.0cm  
28.0664.34 34.0cm

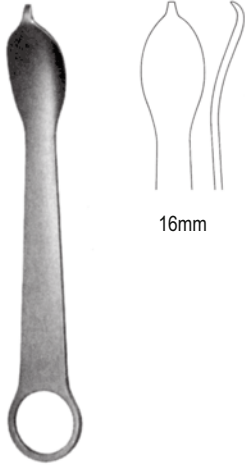

16mm

28.0670.12 12.0cm

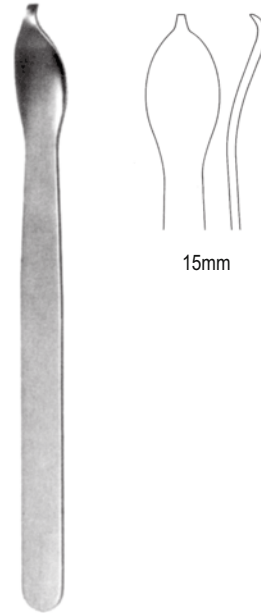

15mm

28.0674.16 16.0cm

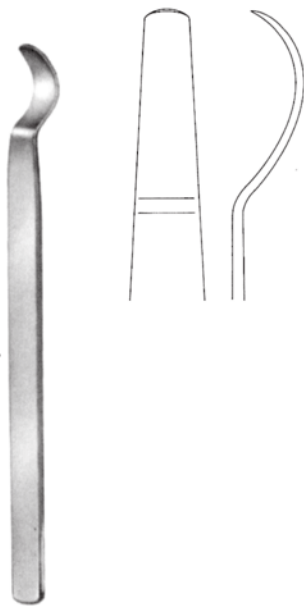

28.0680.14 14.0cm

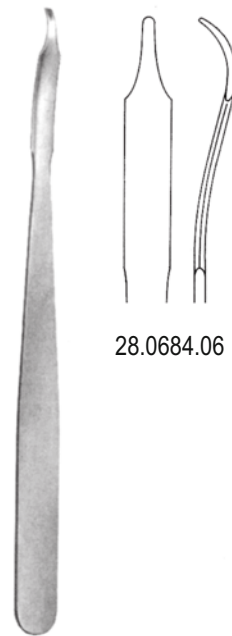

28.0684.06

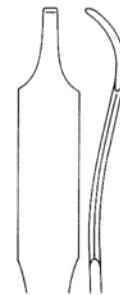

28.0684.08

MINI-HOHMANN  
16.0cm



**HOHMANN**  
28.0690.08 8mm

**HOHMANN**  
28.0690.18 18mm

**HOHMANN**  
28.0690.43 43mm

**HOHMANN**  
28.0690.70 70mm



**HOHMANN**  
28.0692.43 43mm

**HOHMANN**  
28.0694.22 22mm

**HOHMANN**  
28.0694.33 33mm

**HOHMANN**  
28.0696.24 24mm

**LANGE-HOHMANN**  
28.0698.22 22mm



**LANGE-HOHMANN**  
28.0700.27 27.0cm  
28.0700.29 29.0cm



**LANGE-HOHMANN**  
28.0702.27 27.0cm  
28.0702.29 29.0cm



**BENNETT**  
28.0710.24 24.0cm  
28.0710.26 26.0cm



**BENNETT**  
28.0712.24 24.0cm  
28.0712.26 26.0cm



**BLOUNT**  
28.0720.26 26.0cm



**BLOUNT**  
28.0722.26 26.0cm



**BLOUNT**  
28.0724.17 17.5cm



**TAYLOR**  
16.5cm  
28.0730.75 75x30mm  
28.0730.10 100x30mm





**SMILLIE**  
14.0cm



28.0734.01  
32x19mm



28.0734.02  
48x19mm



28.0734.03  
57x19mm



28.0734.04  
52x13mm



28.0734.05  
12x13mm

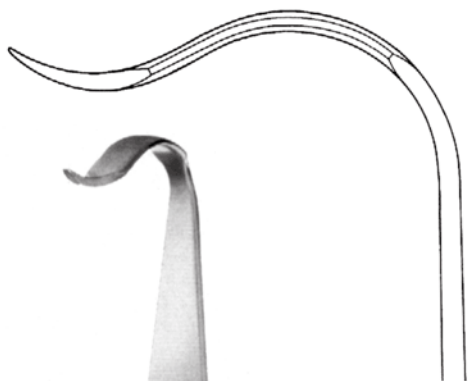

28.0740.17  
17.0cm, 56x10mm



28.0744.22  
22.0cm, 38x9mm





**SMILLIE**  
17.0cm



28.0750.01



28.0750.02



28.0750.03



**MOD. SCHWEDEN**  
17.0cm



left cutting  
28.0754.01



right cutting  
28.0754.02



**BIRCHER**  
19.0cm



28.0760.01



28.0760.02



28.0764.18  
18.0cm



28.0770.01



28.0770.02

**NEFF**  
22.0cm



**SALENIUS**  
28.0774.01 22.0cm



**SALENIUS**  
28.0774.02 22.0cm



**LOWE-BRECK**  
28.0780.25 25.0cm



**DOWNING**  
28.0784.25 25.0cm

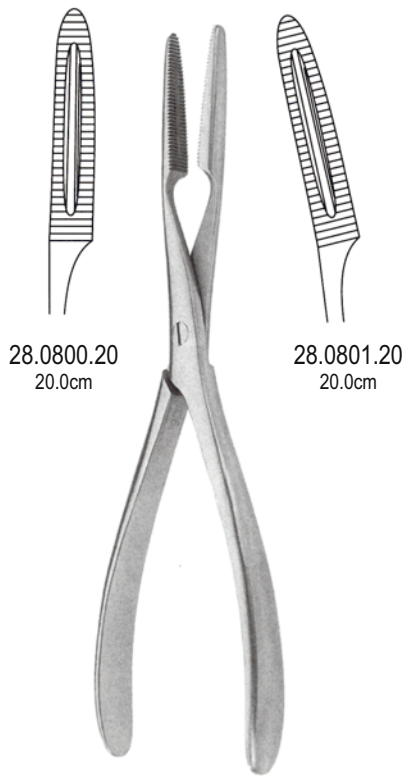

28.0800.20  
20.0cm

28.0801.20  
20.0cm



**VAN BUREN**  
28.0806.23  
23.0cm

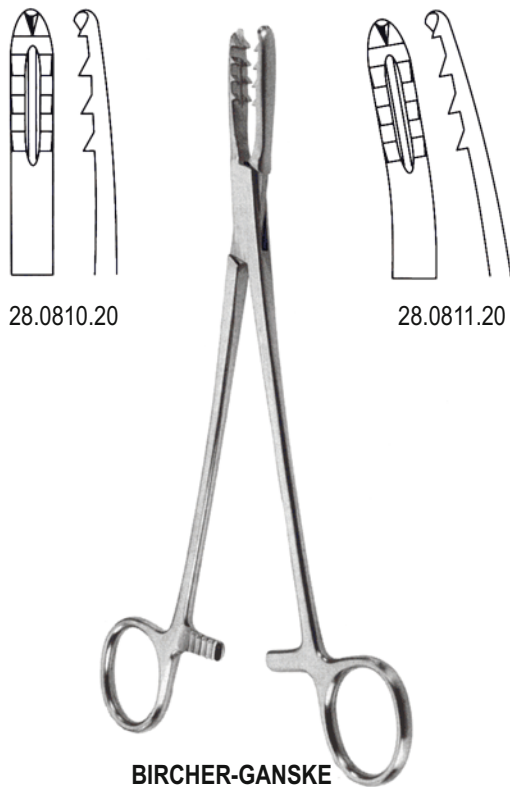

28.0810.20

28.0811.20

**BIRCHER-GANSKE**  
20.0cm



28.0816.19

**MARTIN**  
19.0cm

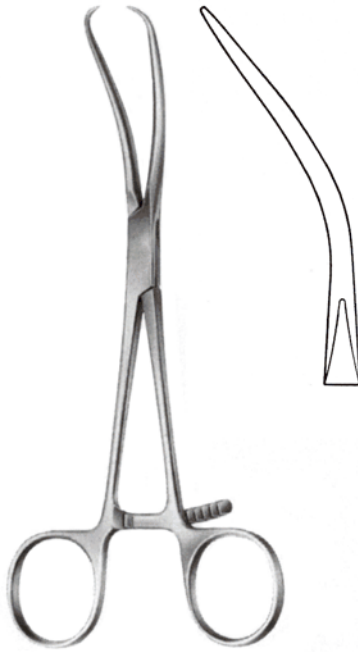

**REILL**  
28.0820.17 17.0cm

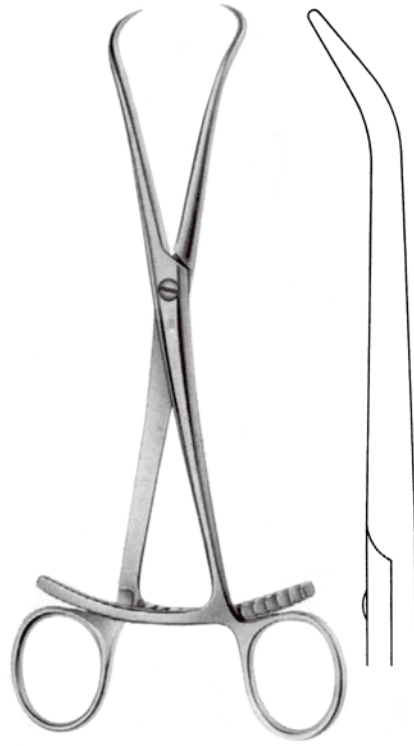

28.0824.20 20.5cm

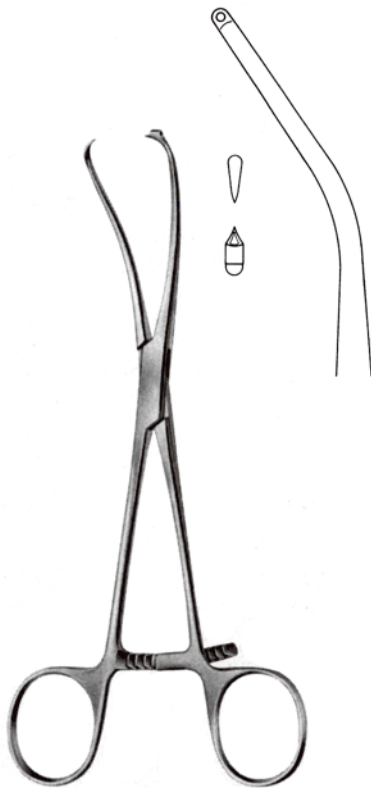

**MEYER**  
28.0830.17 17.0cm



28.0834.21 21.0cm



**DINGMANN**  
28.0840.19 19.0cm



**DINGMANN (Modif)**  
28.0842.19 19.0cm



**LEWIN**  
28.0846.17 17.5cm



**BRUNS**  
28.0850.18 18.5cm



28.0854.13 13.5cm



28.0860.12 12.0cm



28.0864.13 13.5cm



28.0870.14 14.0cm

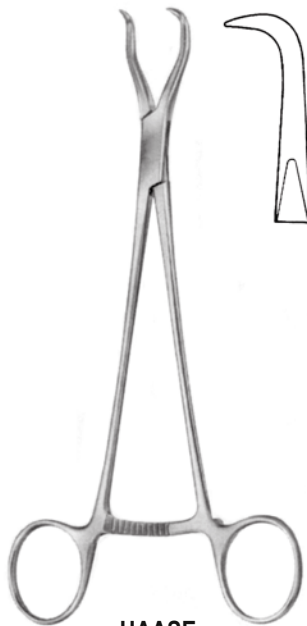

**HAASE**  
28.0874.16 16.5 cm

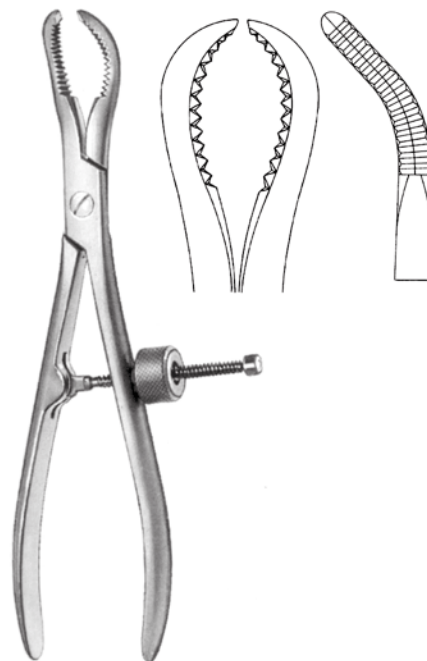

28.0880.16 16.0 cm  
28.0880.24 24.0cm



28.0890.19 19.0cm



28.0890.23 23.0cm

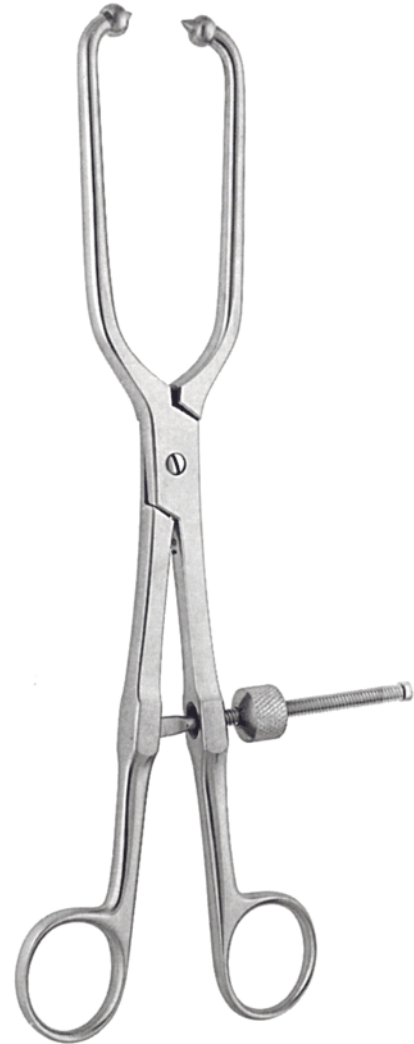

28.0892.25 25.0cm



28.0896.18 18.5cm



28.0900.40 40.0cm

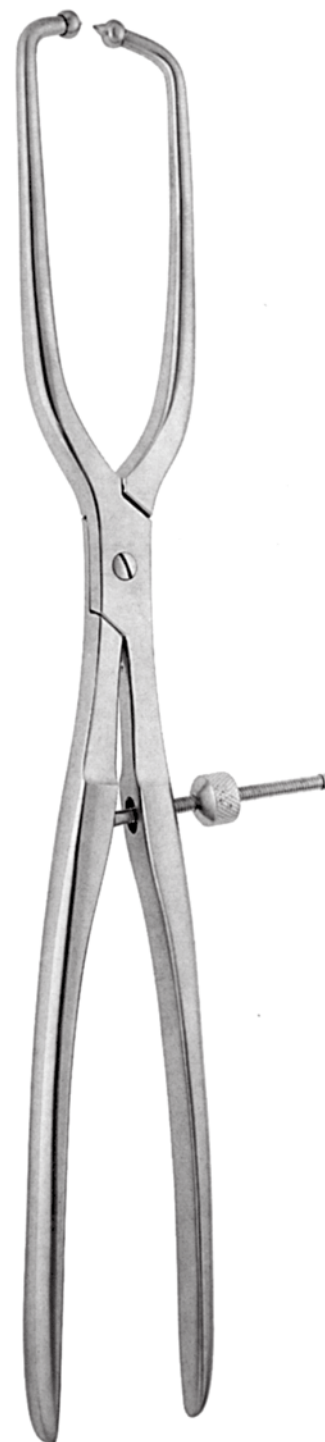

28.0902.40 40.0cm





**FROSCH**  
28.0910.18 18.0cm



**FERGUSSON**  
28.0914.21 21.0cm



**LANGENBECK**  
28.0920.21 21.0cm



28.0924.20 20cm



**SEMB**  
28.0930.19 19.0cm



**SEMB**  
28.0934.19 19.0cm

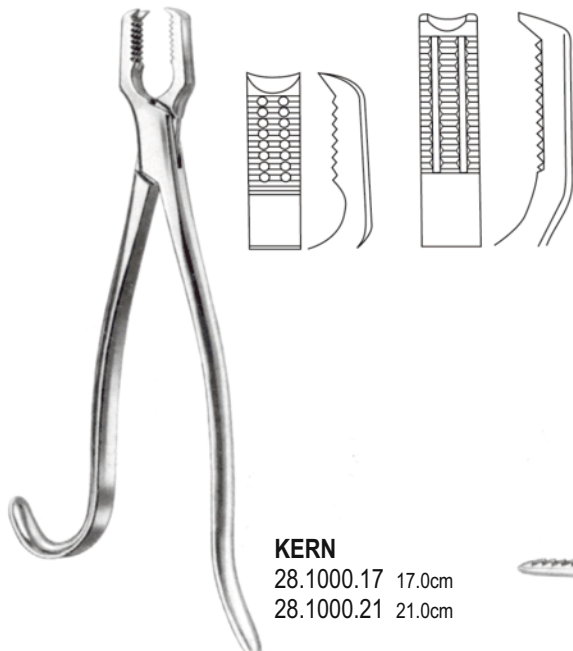

**KERN**  
28.1000.17 17.0cm  
28.1000.21 21.0cm

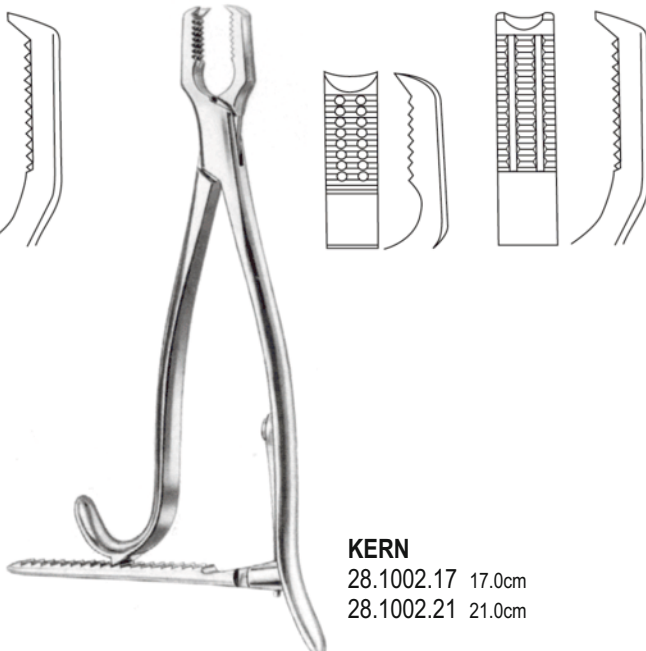

**KERN**  
28.1002.17 17.0cm  
28.1002.21 21.0cm

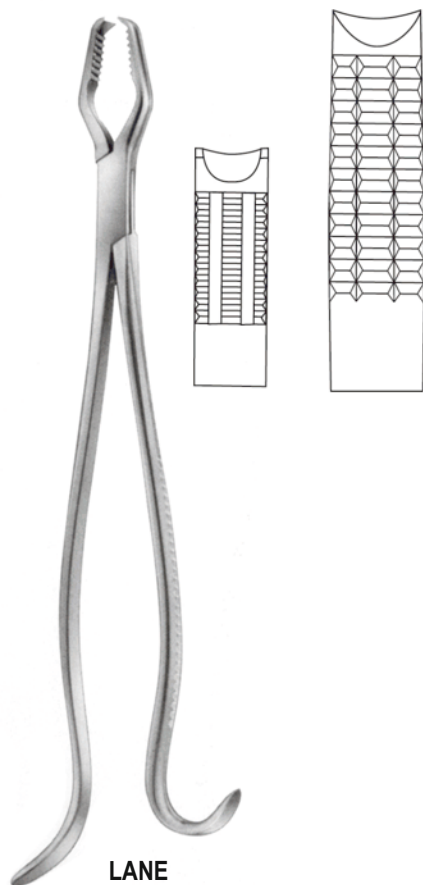

**LANE**  
28.1004.33 33.0cm  
28.1004.45 45.0cm

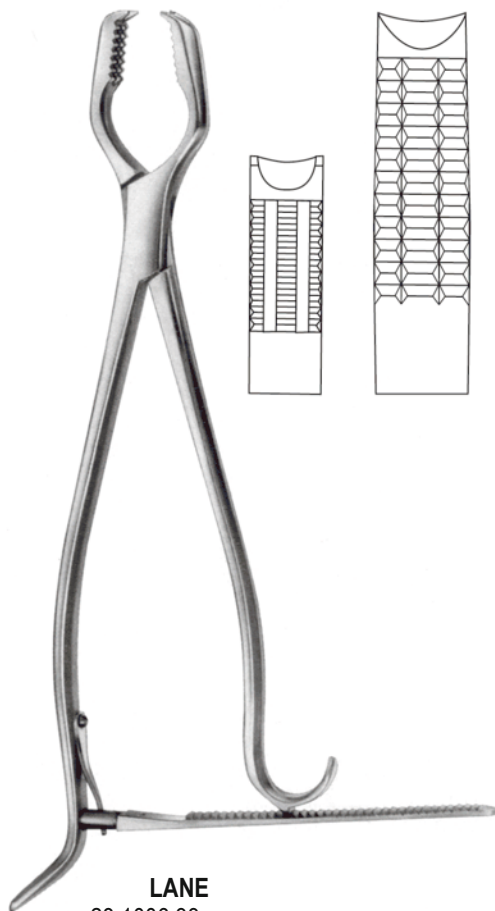

**LANE**  
28.1006.33 33.0cm  
28.1006.45 45.0cm



**FARABEU**  
28.1010.23 23.0cm  
28.1010.26 26.0cm



**FARABEU-LAMBOTTE**  
28.1014.26 26.0cm



**TUFFIER**  
28.1020.27 27.0cm



**LAMBOTTE**  
28.1030.22 22.0cm  
28.1030.27 27.0cm  
28.1030.30 30.0cm



**LAMBOTTE**  
28.1032.22 22.0cm  
28.1032.26 26.0cm  
28.1032.33 33.0cm



**LAMBOTTE**  
28.1034.19 19.0cm  
28.1034.23 23.0cm  
28.1034.26 26.0cm



**ULRICH**  
28.1040.23 - 28.1040.28

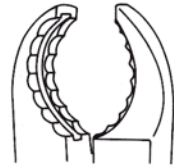
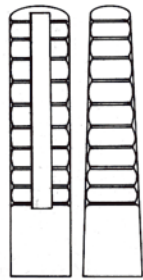

28.1040.23 23.0cm  
28.1044.22 22.0cm



28.1040.25 25.0cm  
28.1044.24 24.0cm

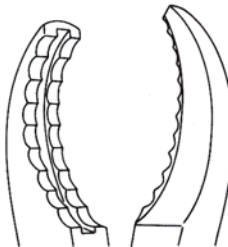

28.1040.28 28.0cm  
28.1044.27 27.0cm



**ULRICH**  
28.1044.22 - 28.1044.27



28.1050.19 19.0cm  
28.1050.26 26.0cm



**ULRICH**  
28.1054.28 28.0cm



**LOWMAN**

- 28.1060.12 12.0cm
- 28.1060.18 18.5cm
- 28.1060.20 20.0cm
- 28.1060.22 22.0cm



**GERSTER-LOWMANN**

- 28.1064.18 18.0cm
- 28.1064.20 20.0cm
- 28.1064.22 22.0cm



**LAMBERT-LOWMAN**

- 2x2 prongs
- 28.1070.18 18.0cm
- 28.1070.20 20.0cm
- 28.1070.22 22.0cm



**LOWMAN-HOGLUND**

- 28.1074.12 12.0cm
- 28.1074.17 17.5cm
- 28.1074.20 20.0cm
- 28.1074.22 22.0cm

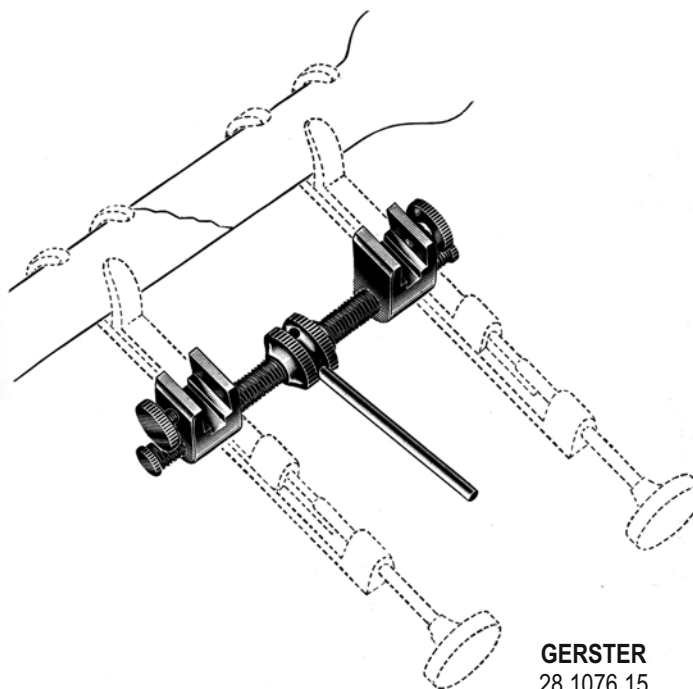

**GERSTER**  
28.1076.15





**VERBRUGGE**  
28.1080.17 17.5cm

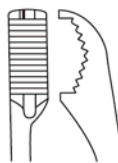

**VERBRUGGE**  
28.1082.17 17.5cm

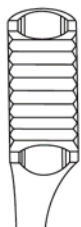

**VERBRUGGE**

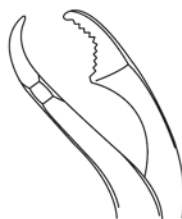

28.1084.25 25.0cm

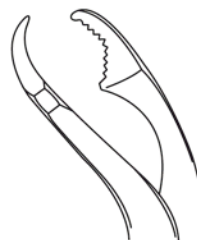

28.1084.26 26.0cm

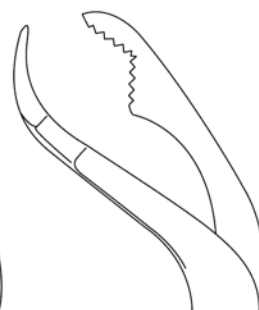

28.1084.27 27.0cm



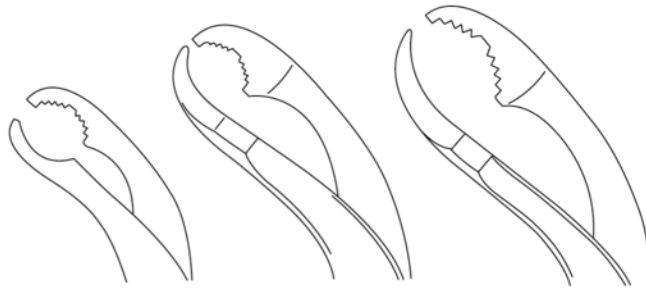
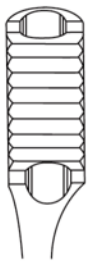

28.1090.15 15.0cm

28.1090.19 19.0cm

28.1090.24 24.0cm

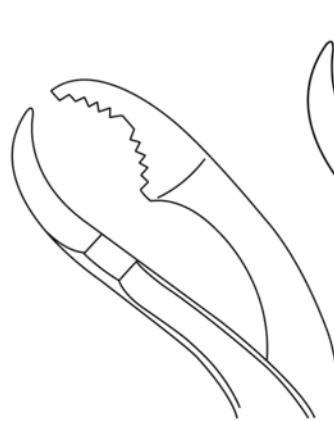

28.1090.26 26.0cm

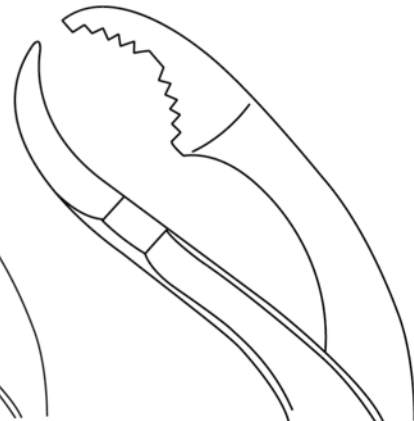

28.1090.28 28.0cm

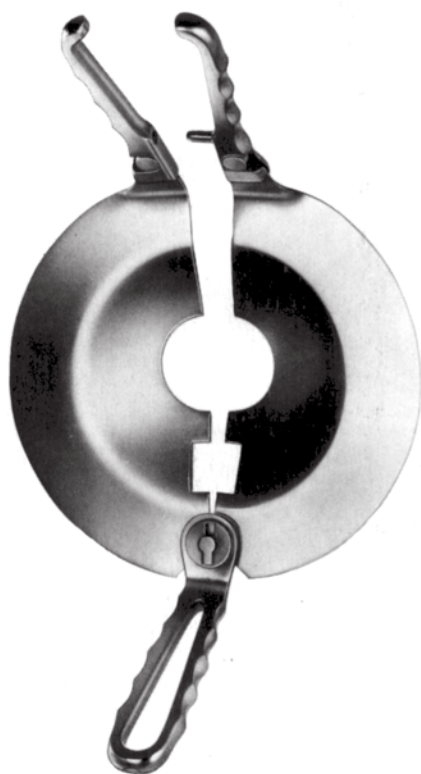

**PERCY**  
28.1094.00

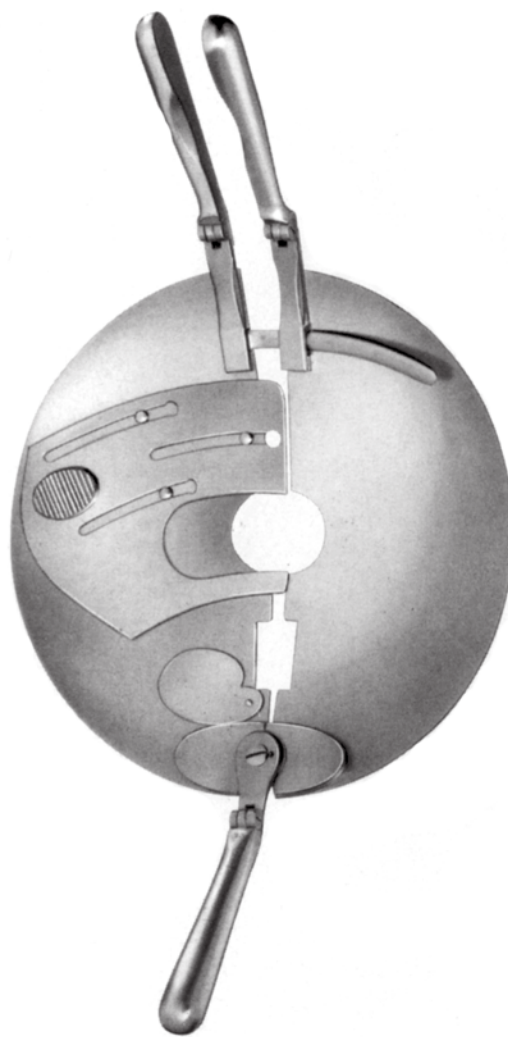

**PERCY**  
28.1096.00

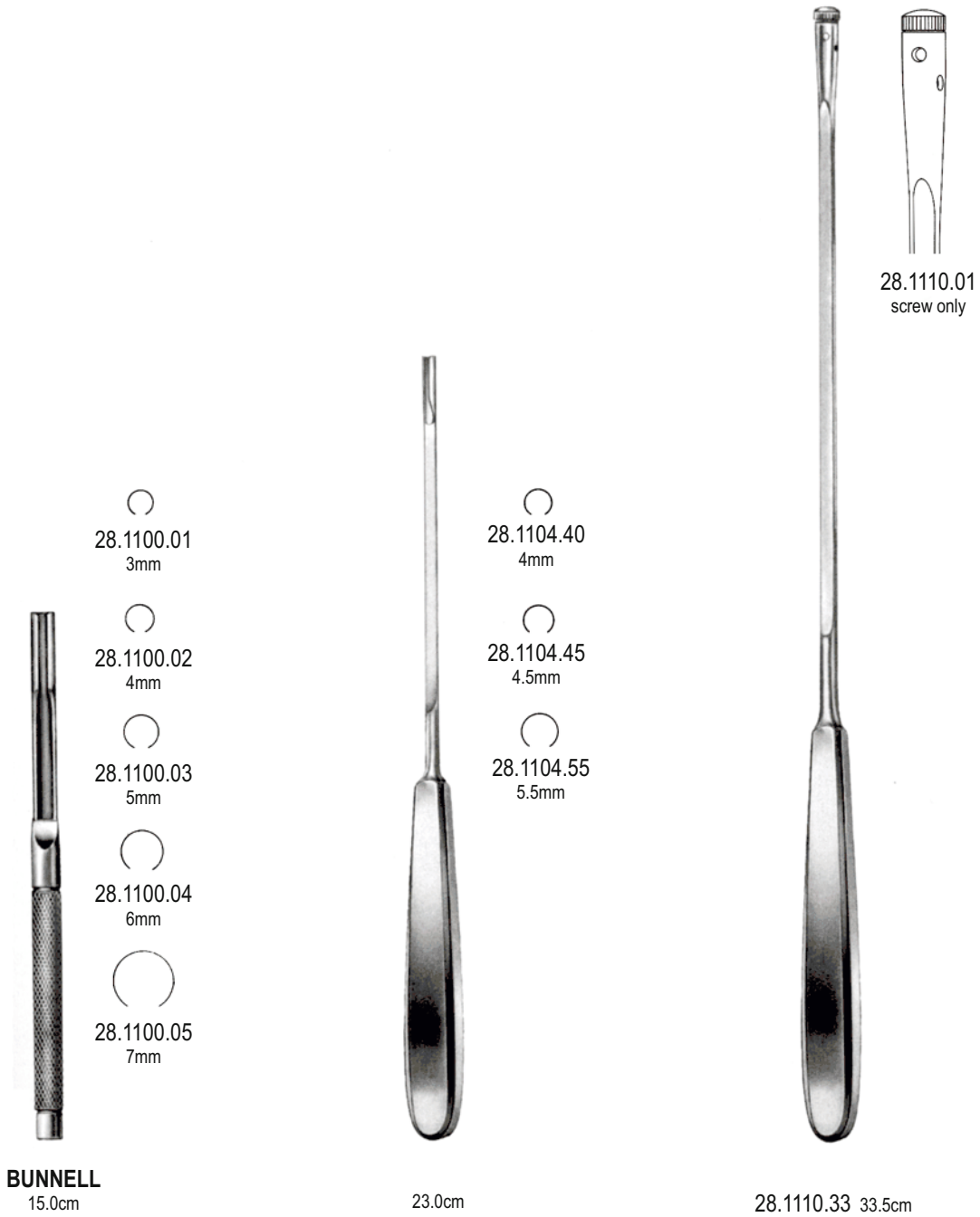

**BUNNELL**  
15.0cm

23.0cm

28.1110.33 33.5cm

28.1110.01  
screw only



**BUNNEL**  
28.1114.23 23.0cm



28.1120.28 28.5cm



**FISCHER**  
28.1124.31 31.0cm



**IDEAL**  
28.1130.10 handle only  
28.1130.00 set



28.1130.01



28.1130.02



28.1130.03



28.1134.01 adult  
28.1134.02 child

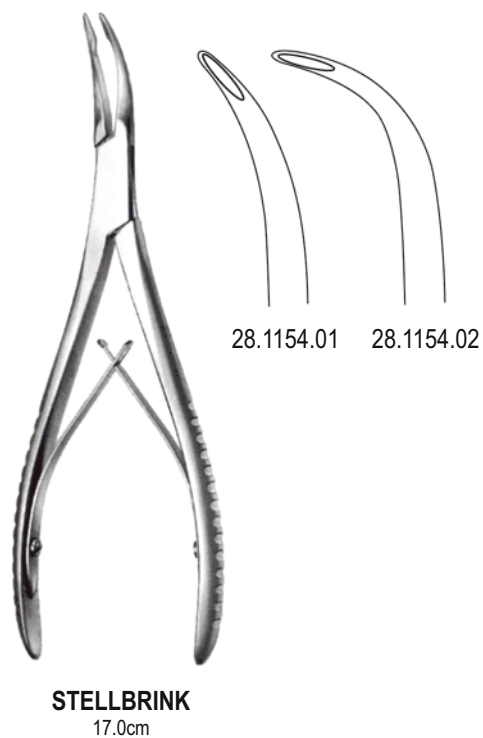



**MINI-FRIEDMAN**  
28.1160.12 12.0cm



**FRIEDMAN**  
28.1160.14 14.0cm



**MEAD**  
28.1164.16 16.5cm



**MEAD**  
28.1166.16 16.5cm



**HARTMANN**  
28.1170.16 16.0cm



**HARTMANN**  
28.1170.18 18.5cm



**JANSEN**  
18.0cm



28.1174.01



28.1174.02



28.1174.03



**BLUMENTHAL**  
15.0cm



28.1180.01



28.1180.02



28.1180.03



**LEMPERT**  
20.0cm



28.1184.20



28.1185.20



**DEFOURMENTEL**  
28.1190.19 19.0cm







**BANE**  
28.1194.18 18.0cm



**ADSON**  
28.1200.21 21.0cm



**BACON**  
28.1204.20 20.0cm



**FISCH**  
17.0cm



28.1210.01



28.1210.02



**LUER**  
28.1214.01 15.0cm



**LUER**  
28.1214.02 15.0cm



**LUER**  
28.1214.03 15.0cm



**LUER**  
28.1220.01 15.0cm



**LUER**  
28.1220.02 15.0cm



**LUER**  
17.0cm



28.1226.17



28.1227.17

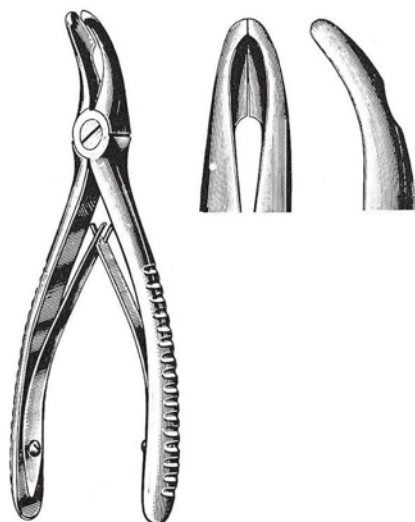

**UNIVERSAL**  
28.1230.13 13.5cm

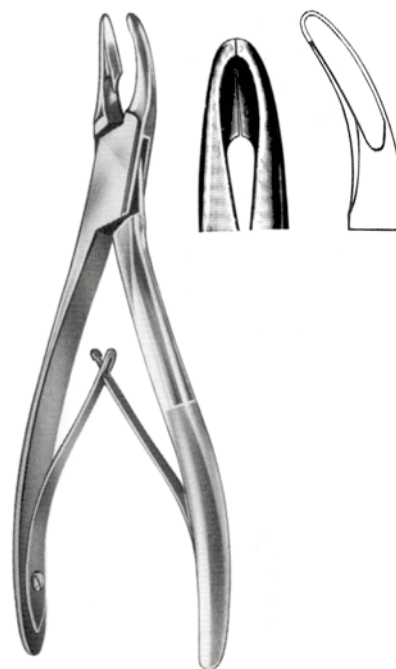

**SHELL**  
28.1234.17 17.0cm



**COTTLE-JANSEN**  
28.1240.18 18.0cm

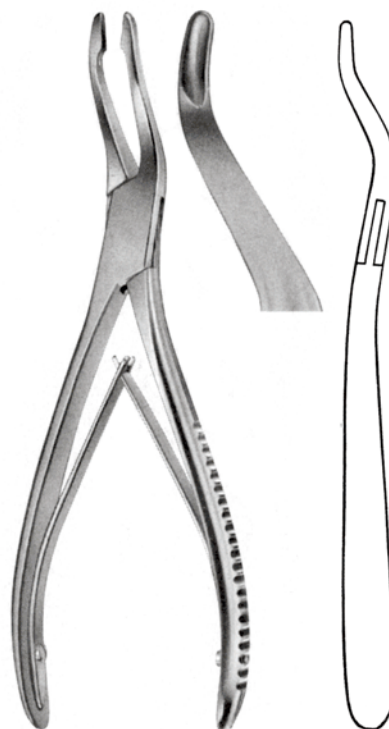

**JANSEN**  
28.1244.19 19.0cm



**SMITH-PETERSEN**  
28.1250.01 24.0cm



**SMITH-PETERSEN**  
28.1250.02 24.0cm



**SMITH-PETERSEN**  
28.1250.03 24.0cm

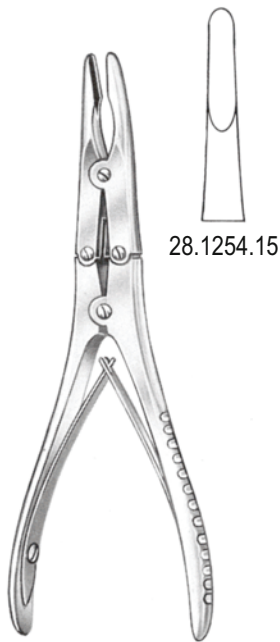

28.1254.15

**BÖHLER**  
15.5cm

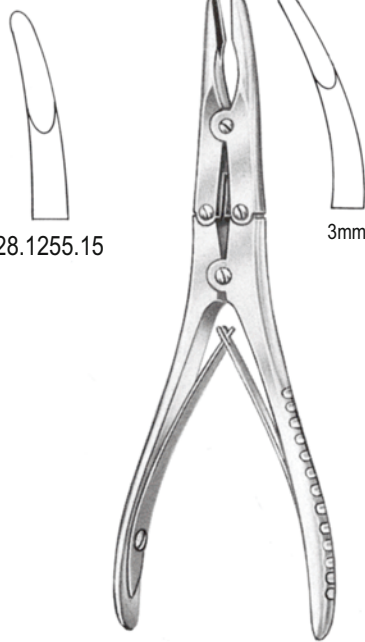

28.1255.15

**KLEINERT-KUTZ**  
28.1260.15 15.0cm



3mm

**GEIGER**  
28.1264.15 15.0cm

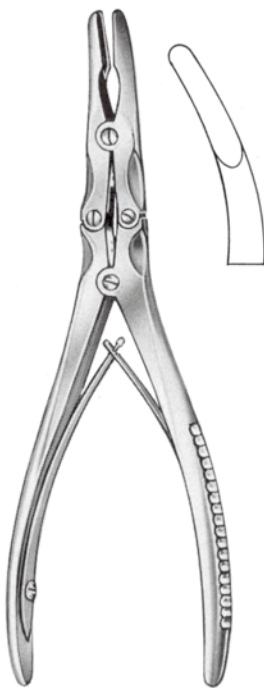

**BEYER**  
28.1270.18 18.0cm



**ZAUFAL-JANSEN**  
28.1274.18 18.0cm



**MAYFIELD**  
28.1280.17 17.0cm



**MARQUARDT**  
28.1284.20 20.0cm

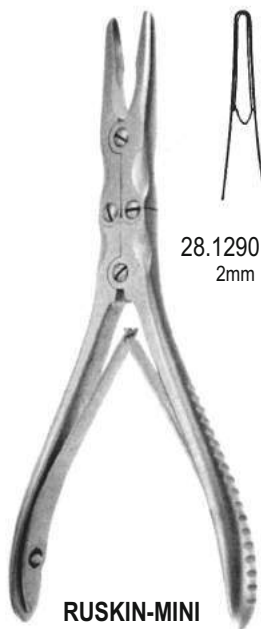

28.1290.02  
2mm

28.1290.03  
3mm

**RUSKIN-MINI**  
15.0cm



28.1291.02  
2mm

28.1291.03  
3mm

**RUSKIN-MINI**  
15.0cm

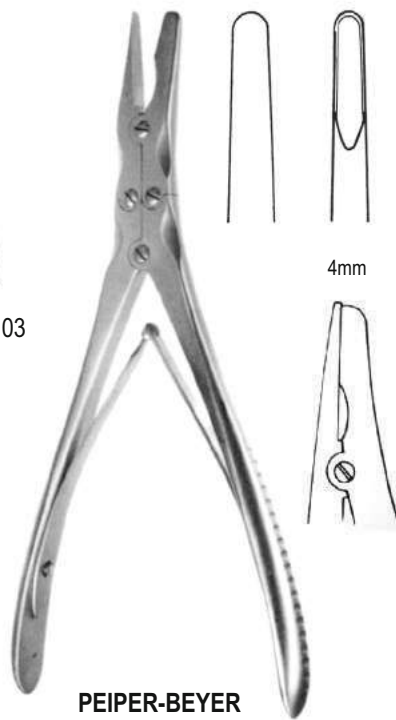

4mm

**PEIPER-BEYER**  
28.1294.18 18.0cm

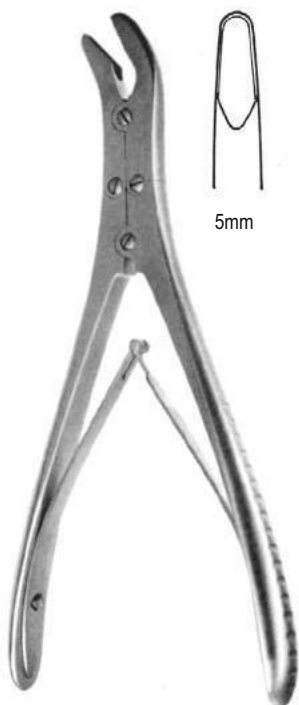

5mm

**RUSKIN**  
28.1300.18 18.0cm

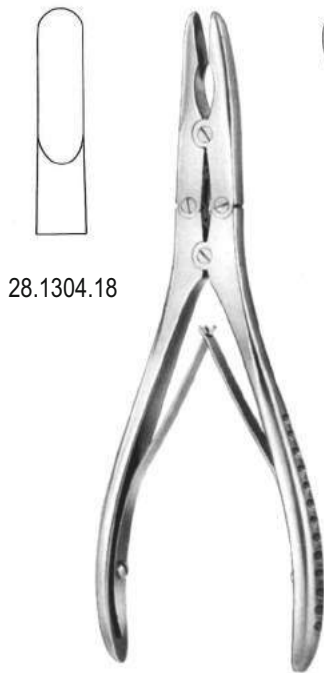

28.1304.18

28.1305.18

**RUSKIN**  
18.0cm



28.1310.23

28.1311.23

**RUSKIN**  
23.0cm





**FRYKHOLM**  
28.1316.24 24cm



28.1320.02

28.1320.03

28.1320.04

**ECHLIN**  
23.0cm

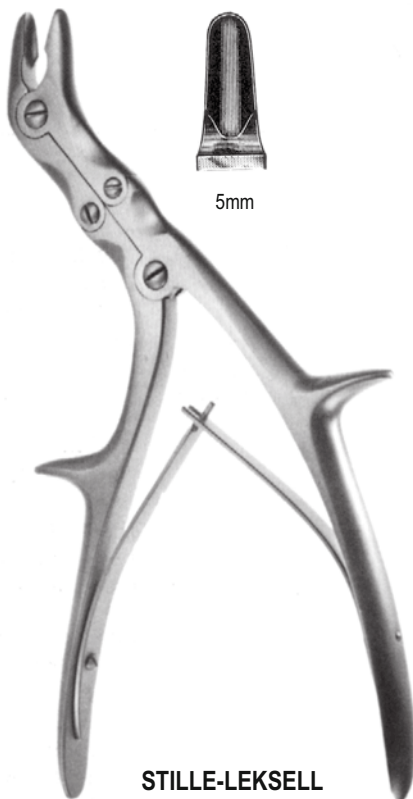

**STILLE-LEKSELL**  
28.1324.23 23.0cm

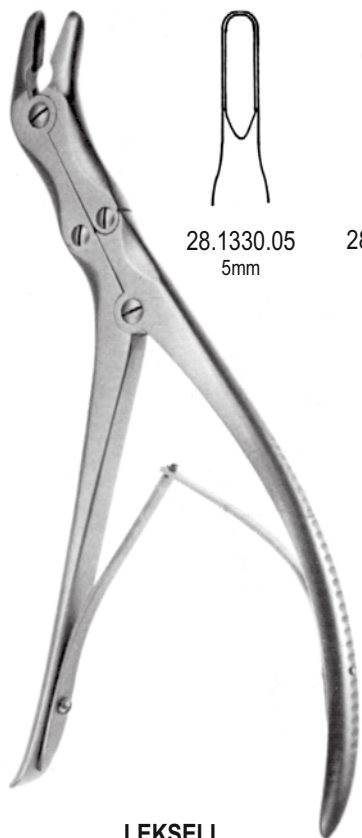

**LEKSELL**  
23.0cm

28.1330.05  
5mm

28.1330.08  
8mm



**LEKSELL-STILLE**  
24.0cm

28.1334.01

28.1334.02





**STILLE**  
28.1340.23 23.0cm



**STILLE-RUSKIN**  
28.1344.23 23.0cm 28.1345.23



**SEMB**  
28.1350.22 22.5cm

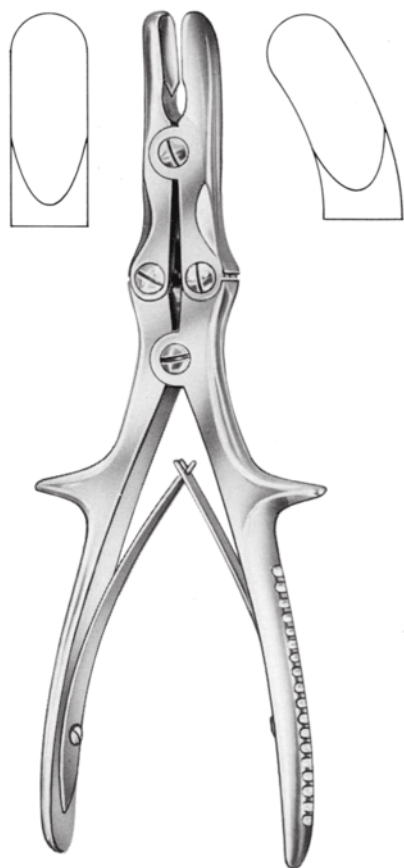

**STILLE-LUER**  
28.1354.22 22.0cm 28.1355.22



**STILLE-LUER**  
28.1360.23 23.0cm 28.1361.23  
28.1360.27 27.0cm 28.1361.27



SAUERBRUCH  
30.0cm



28.1364.01



28.1364.02



28.1366.01



28.1366.02

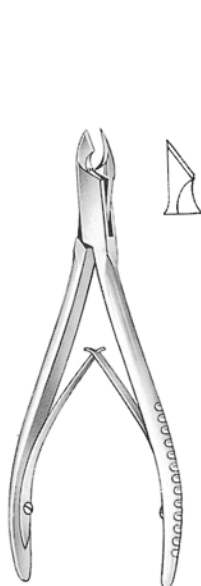

28.1370.12 12.0cm

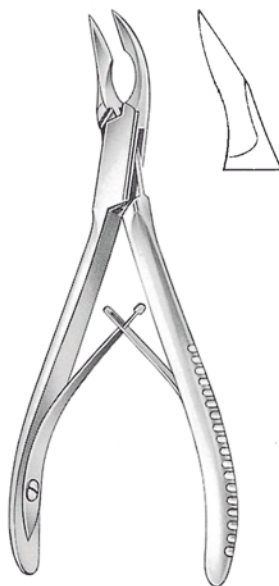

**CLEVELAND**  
28.1374.15 15.0cm

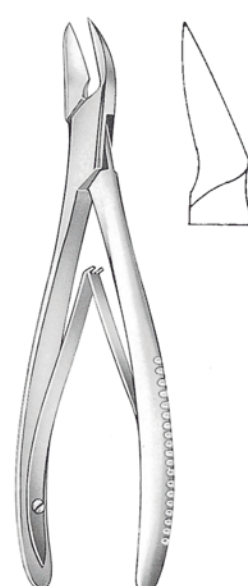

**CLEVELAND**  
28.1376.17 17.0cm



**CLEVELAND**  
16.0cm

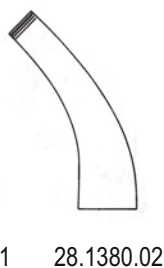

28.1380.01 28.1380.02

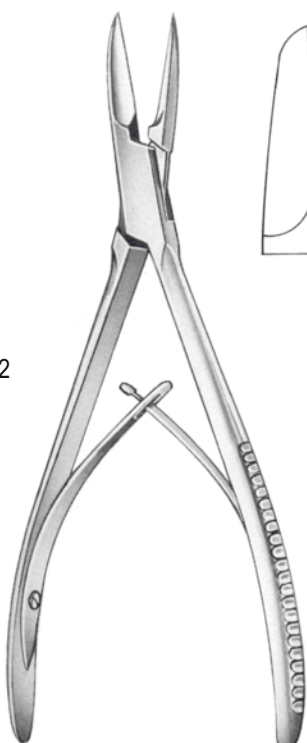

**COTTLE-KAZANJIAN**  
28.1384.19 19.0cm



**MARKWALDER**  
28.1390.20 20.0cm

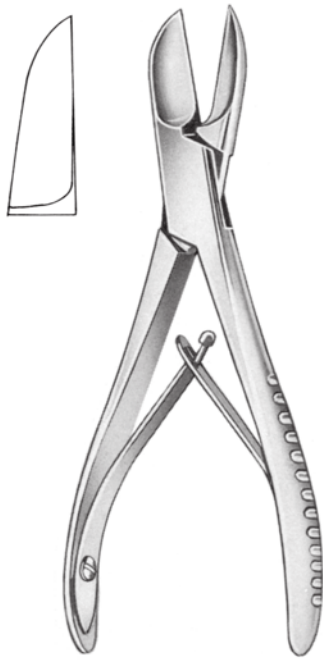

**LISTON**

28.1400.14 14.0cm 28.1401.14  
28.1400.17 17.0cm 28.1401.17  
28.1400.19 19.0cm 28.1401.19  
28.1400.22 22.0cm 28.1401.22

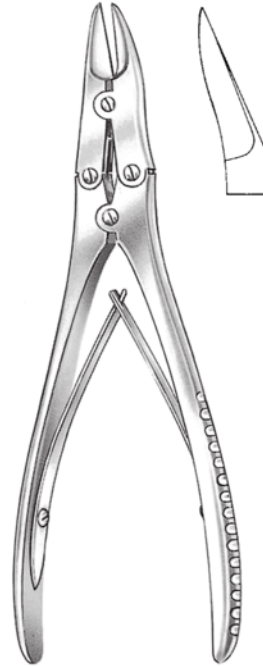

**MC INDOE**

28.1406.17 17.5cm



28.1410.15 15.0cm



28.1414.15

28.1415.15



28.1420.18



28.1421.18



**RUSKIN-LISTON**

18.5cm



**TUDOR-EDWARDS**  
28.1426.23 23.0cm



**SEMB**  
28.1430.24 24.0cm



**STILLE-LISTON**  
28.1434.27 27.0cm

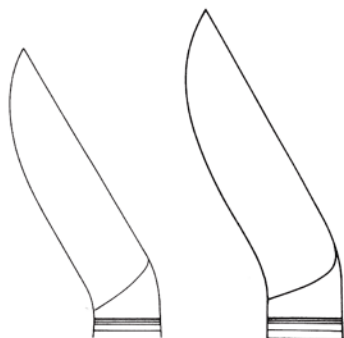

28.1441.23

28.1441.27



**STILLE LISTON**  
28.1440.27 27.0cm



**STILLE LISTON**  
28.1441.23 23.0cm  
28.1441.27 27.0cm



**LISTON KEY**  
28.1446.27 27.0cm



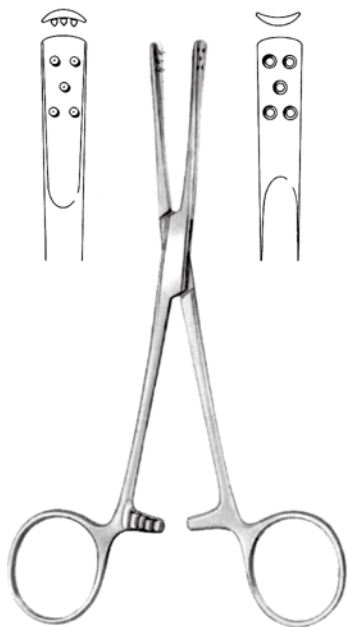

**PENNER**  
28.1450.15 15.5cm

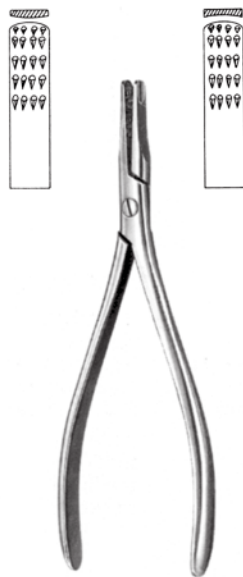

**RADOLF**  
28.1454.13 13.5cm



28.1470.01 saw  
28.1470.02 key

28.1470.00 17.0cm



28.1472.01 saw  
28.1472.02 key

28.1472.00 17.0cm



28.1474.01 saw  
28.1474.02 key

**WALTON**  
28.1474.00 16.0cm

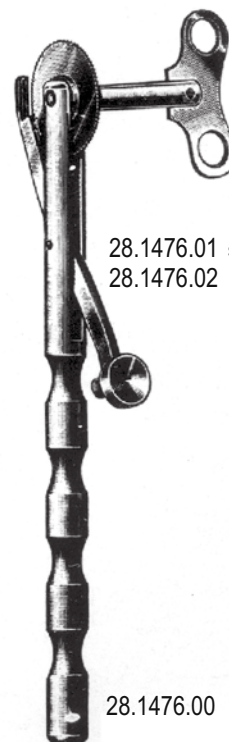

28.1476.01 saw  
28.1476.02 key

28.1476.00





28.1480.26 26.5cm

28.1482.27 27.0cm

28.1484.28 28.0cm

28.1486.28 28.0cm

28.1488.00