

12

Страницы раздела
001-016

ПИНЦЕТЫ DRESSING & TISSUE FORCEPS

Перейти в **СОДЕРЖАНИЕ**





STANDARD

STANDARD

12.0010.10	10.5cm
12.0010.11	11.5cm
12.0010.13	13.0cm
12.0010.14	14.5cm
12.0010.16	16.0cm
12.0010.18	18.0cm
12.0010.20	20.0cm
12.0010.23	23.0cm
12.0010.25	25.0cm
12.0010.30	30.0cm

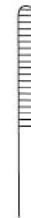

NARROW

12.0012.10	10.5cm
12.0012.11	11.5cm
12.0012.13	13.0cm
12.0012.14	14.5cm
12.0012.16	16.0cm
12.0012.18	18.0cm
12.0012.20	20.0cm
12.0012.23	23.0cm
12.0012.25	25.0cm
12.0012.30	30.0cm



USA MODEL

12.0016.12	12.0cm
12.0016.13	13.0cm
12.0016.14	14.5cm
12.0016.15	15.0cm
12.0016.18	18.0cm
12.0016.21	21.0cm
12.0016.25	25.0cm
12.0016.31	31.0cm



12.0018.12	12.0cm
12.0018.13	13.0cm
12.0018.14	14.5cm
12.0018.15	15.0cm
12.0018.18	18.0cm
12.0018.21	21.0cm
12.0018.25	25.0cm

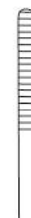



STILLE
12.0022.15
15.0cm

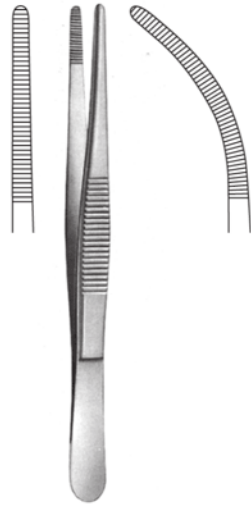

OCHSNER
12.0028.14
14.0cm

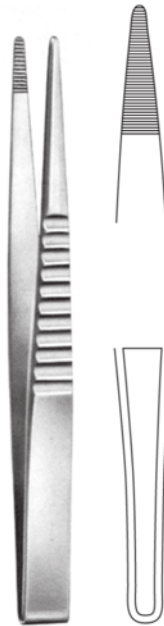

12.0032.12 12.0cm
12.0032.15 15.0cm
12.0032.18 18.0cm
12.0032.20 20.0cm
12.0032.25 25.0cm

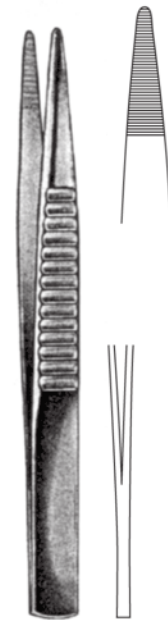

12.0038.12 12.0cm
12.0038.15 15.0cm
12.0038.18 18.0cm
12.0038.20 20.0cm
12.0038.25 25.0cm

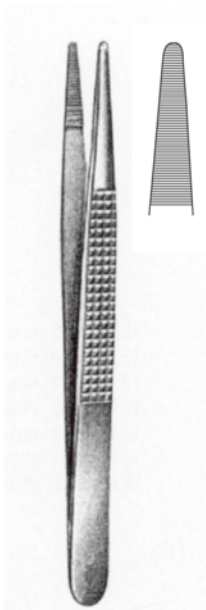

BONNEY
12.0046.17
17.5cm



RAMSEY
12.0050.18
18.0cm



DUEHRSSEN
12.0054.20
20.0cm



WANGENSTEEN
12.0058.23
23.0cm



ADSON
12.0066.12 12.0cm
12.0066.15 15.0cm
12.0066.19 19.0cm



McINDOE
12.0070.15 15.0cm



SEMKEN
12.0076.12 12.0cm 12.0077.12
12.0076.15 15.0cm 12.0077.15



CUSHING
12.0080.17 17.0cm 12.0081.17



POTTS.SMITH
12.0084.18 18.0cm
12.0084.21 21.0cm
12.0084.25 25.0cm
12.0084.30 30.0cm



WAUGH
12.0088.15 15.0cm
12.0088.18 18.0cm
12.0088.20 20.0cm

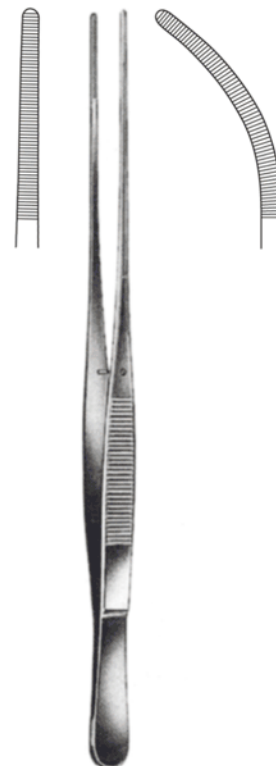

BROPHY
12.0092.20 20.0cm 12.0093.20



GERALD
12.0094.18 18.0cm

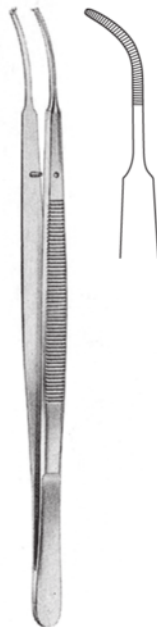

GERALD
12.0095.18 18.0cm



GERALD
12.0098.18 18.0cm



TAYLOR
12.0100.17 17.5cm
12.0101.17 17.5cm



TAYLOR
12.0102.17
18.5cm



TAYLOR
12.0104.17
17.5cm



JEFFERSON
12.0106.18
18.0cm, 180mm



ADSON
12.0108.18
18.0cm, 180mm

12 |

Пинцеты хирургические Tissue Forceps



STANDARD

	SLENDER 1:2	DELICATE 1:2	REGULAR 1:2	2:3	3:4	4:5
10.0cm			12.0114.10	12.0116.10	12.0118.10	12.0120.10
11.0cm	12.0110.11		12.0114.11	12.0116.11	12.0118.11	12.0120.11
13.0cm	12.0110.13	12.0112.13	12.0114.13	12.0116.13	12.0118.13	12.0120.13
14.0cm	12.0110.14	12.0112.14	12.0114.14	12.0116.14	12.0118.14	12.0120.14
16.0cm	12.0110.16	12.0112.16	12.0114.16	12.0116.16	12.0118.16	12.0120.16
18.0cm	12.0110.18	12.0112.18	12.0114.18	12.0116.18	12.0118.18	12.0120.18
20.0cm	12.0110.20	12.0112.20	12.0114.20	12.0116.20	12.0118.20	12.0120.20
23.0cm			12.0114.23			
25.0cm			12.0114.25	12.0116.25	12.0118.25	12.0120.25
30.0cm			12.0114.30	12.0116.30	12.0118.30	12.0120.30



USA MODEL

12.0cm	12.0124.12			
13.0cm	12.0124.13	12.0126.13	12.0128.13	12.0130.13
14.0cm	12.0124.14	12.0126.14	12.0128.14	12.0130.14
15.0cm	12.0124.15	12.0126.15	12.0128.15	12.0130.15
18.0cm	12.0124.18			
21.0cm	12.0124.21			
25.0cm	12.0124.25			
31.0cm	12.0124.31			

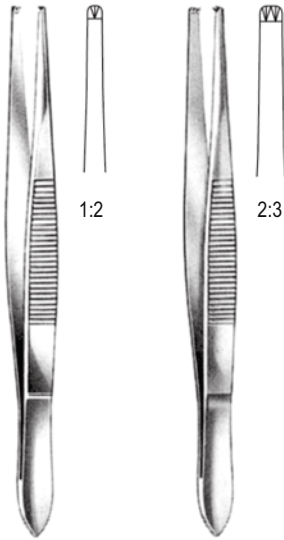

STILLE
12.0134.15 15.0cm
12.0136.15 15.0cm

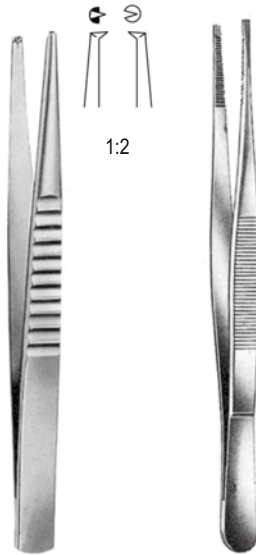

TREVES
12.0140.12 12.5cm
12.0140.15 15.0cm
12.0140.18 18.0cm
12.0140.20 20.0cm
12.0140.25 25.0cm

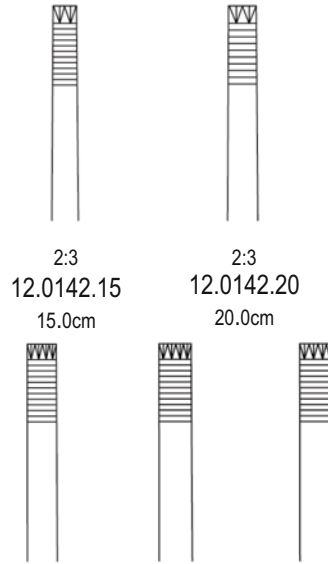

ADLERKREUTZ
12.0144.15 15.0cm
12.0144.20 20.0cm
12.0144.25 25.0cm

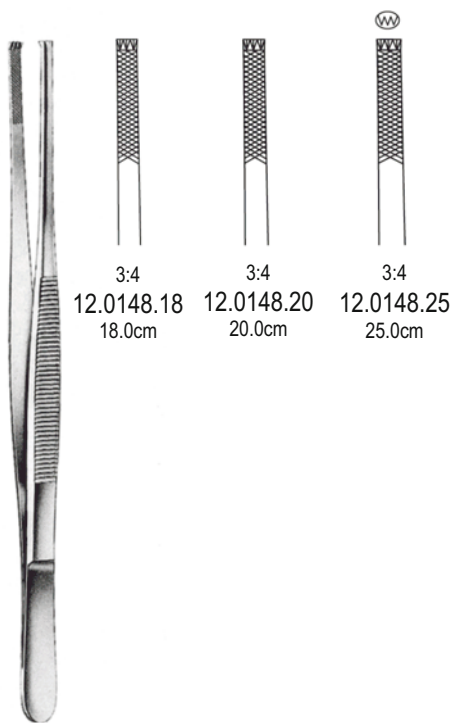

STILLE-BARRAYA

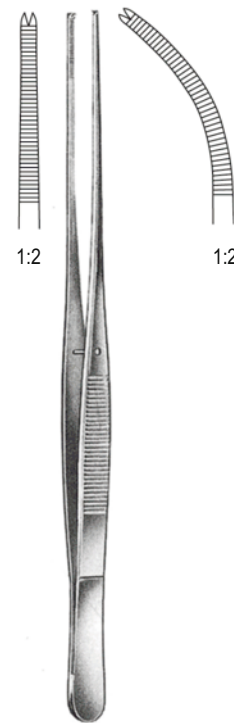

BROPHY
12.0152.20 20.0cm 12.0153.20

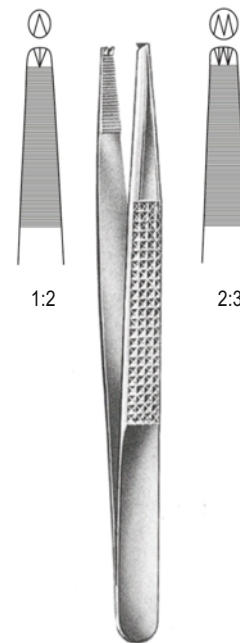

BONNEY
12.0156.18 18.0cm 12.0158.18



ADSON
12.0160.18 18.0cm

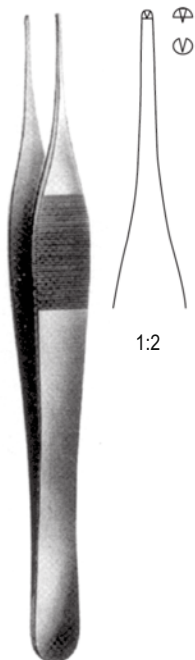

JEFFERSON
12.0162.18 18.0cm

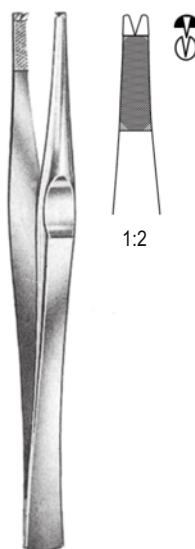

LANES
12.0166.12 12.5cm
12.0166.15 15.0cm
12.0166.18 18.0cm
12.0166.20 20.0cm

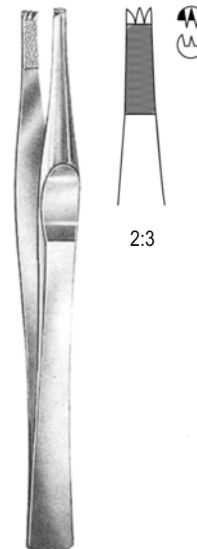

LANES
12.0168.12 12.5cm
12.0168.15 15.5cm
12.0168.18 18.0cm
12.0168.20 20.0cm

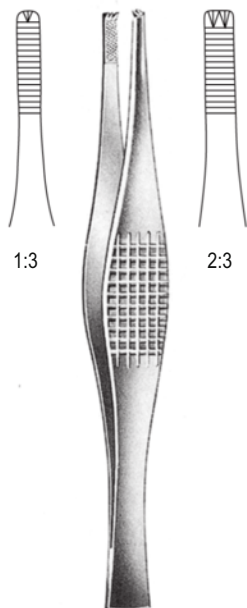

FERRIS-SMITH
12.0172.18 18.0cm 12.0174.18



RAMSAY
12.0178.18
12.0180.18
18.0cm

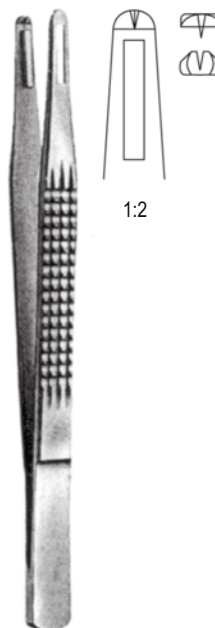

CHARNLEY
12.0182.18 18.0cm



JEANS
12.0188.14 14.5cm
12.0188.17 17.5cm

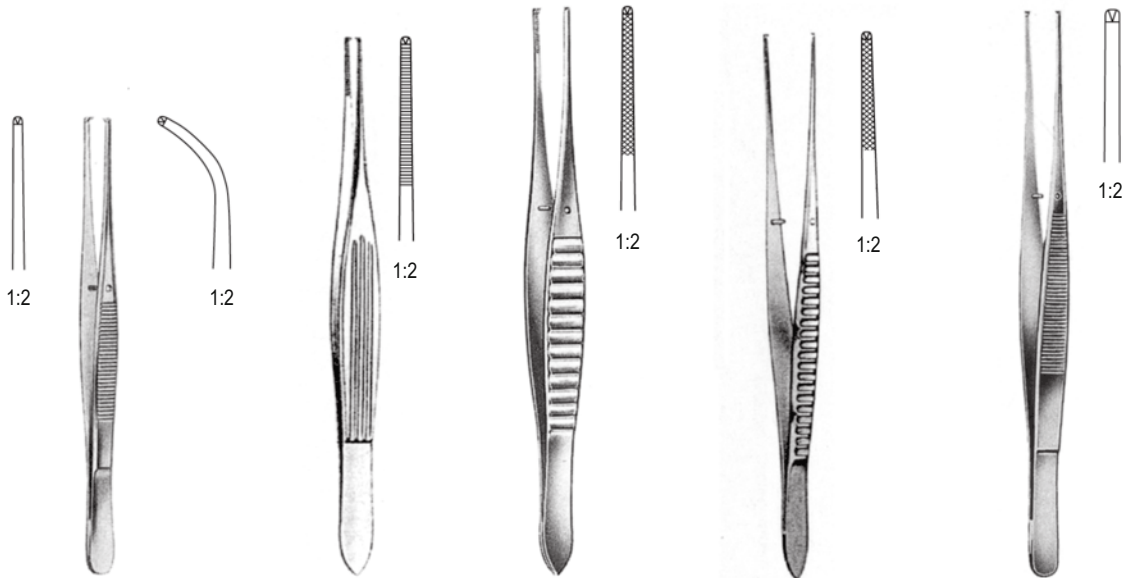

SEMKEN		McINDOE		GILLIES		WAUGH		POTTS.SMITH
12.0196.12 12.5cm	12.0197.12	12.0200.15 15.0cm		12.0204.15 15.0cm		12.0208.15 15.0cm		12.0212.18 18.0cm
12.0196.15 15.0cm	12.0197.15					12.0208.18 18.0cm		12.0212.21 21.0cm
						12.0208.20 20.0cm		12.0212.25 25.0cm
								12.0212.30 30.0cm

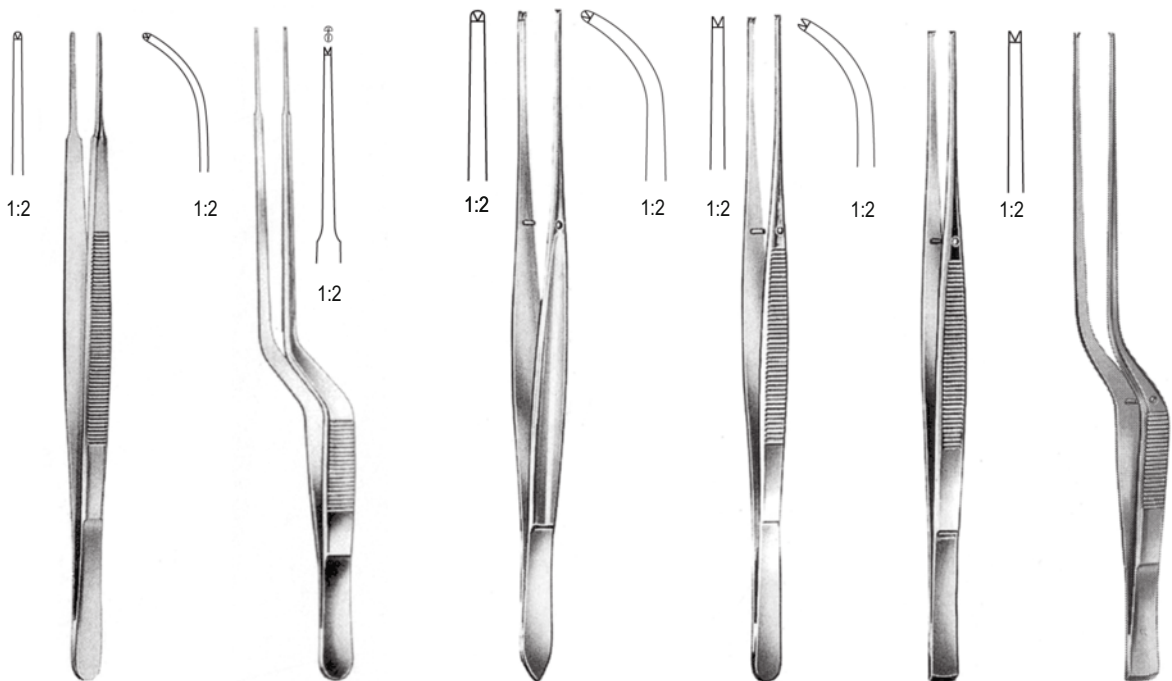

GERALD		GERALD		CUSHING		TAYLOR		TAYLOR		TAYLOR
12.0218.18 18.0cm		12.0220.18 18.0cm		12.0222.17 17.5cm		12.0228.17 17.5cm		12.0232.17		12.0234.17
12.0219.18 18.0cm				12.0223.17 17.5cm		12.0229.17 17.5cm		17.5cm		17.5cm

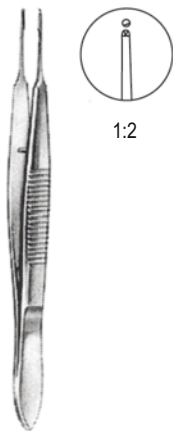

12.0240.11
11.0cm

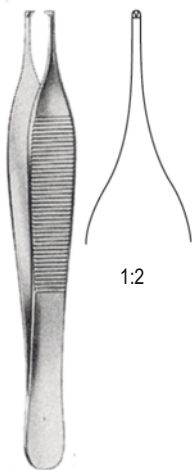

ADSON
12.0246.12 12.0cm
12.0246.15 15.0cm

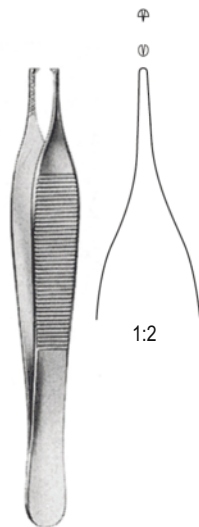

ADSON
12.0250.12 12.0cm

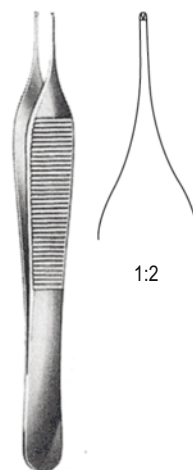

MICRO-ADSON
12.0254.12 12.0cm



ADSON-BROWN
12.0258.12 12.0cm



BROWN
12.0262.15 15.0cm
12.0262.20 20.0cm
12.0262.25 25.0cm



GRAEFE
12.0266.10 10.0cm

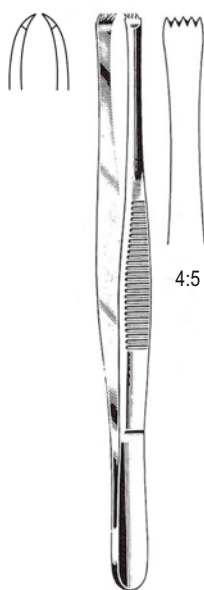

STONE
12.0270.15 15.0cm

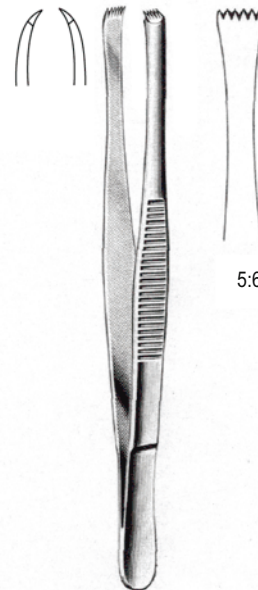

LERCHE
12.0274.15 15.0cm

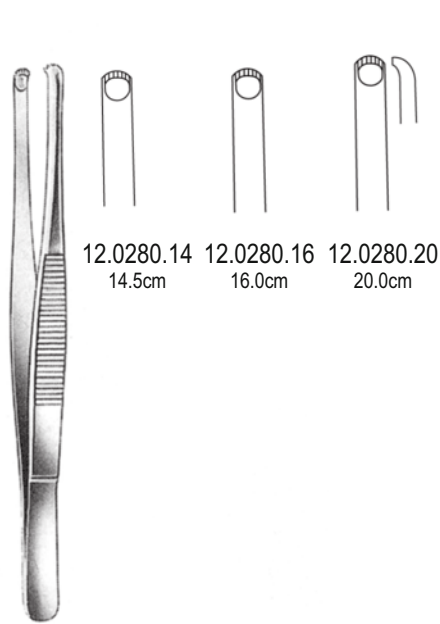

DURANTE

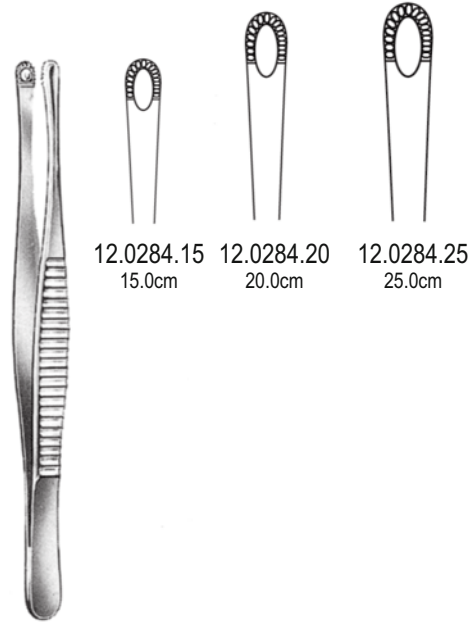

RUSS MODELL



MAYO RUSS
12.0288.23 23.0cm



YASARGIL
22.0cm



YASARGIL
22.0cm



HEIFETZ
22.0cm



MICRO ADSON

12.0302.12 12.0cm

12.0306.12 12.0cm

12.0306.16 16.0cm

12.0308.12 12.0cm

12.0308.16 16.0cm

10.5cm

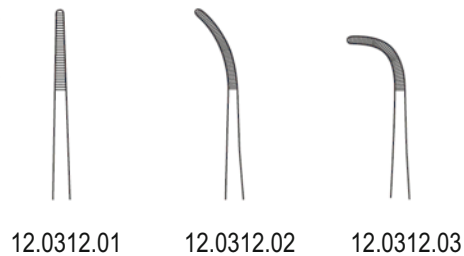

12.0312.01

12.0312.02

12.0312.03

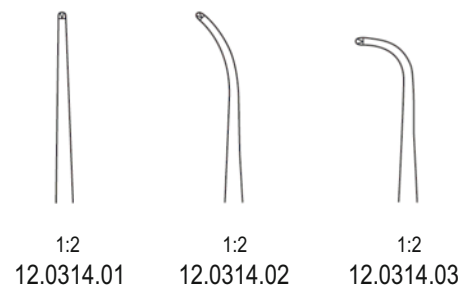

1:2
12.0314.01

1:2
12.0314.02

1:2
12.0314.03



12.0318.09 09.0cm 12.0319.09 09.0cm 12.0320.09 09.0cm 12.0321.09
 12.0318.10 10.5cm 12.0319.10 10.5cm 12.0320.10 10.5cm 12.0321.10
 12.0318.11 11.5cm 12.0319.11 11.5cm 12.0320.11 11.5cm 12.0321.11
 12.0318.12 12.0cm 12.0319.12 12.0cm 12.0320.12 12.0cm 12.0321.12

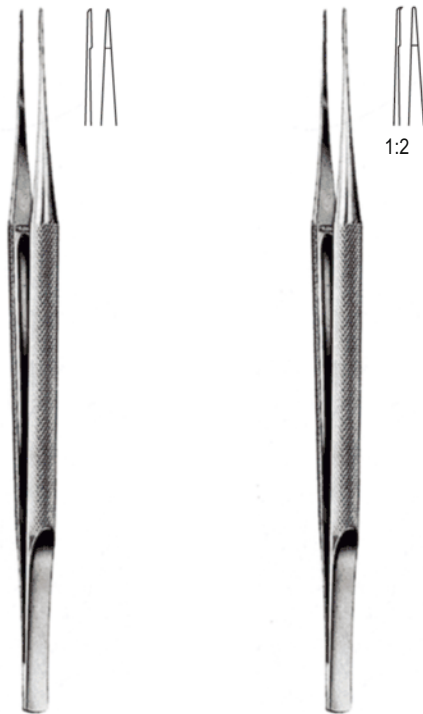

GOMEL

12.0326.18 18.0cm 12.0328.18

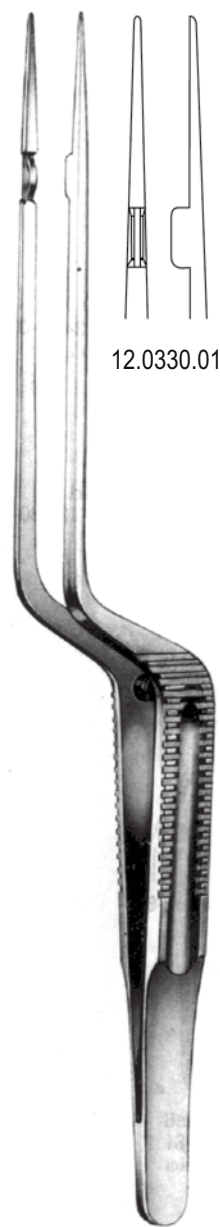

12.0330.01

22.5cm



12.0330.02



12.0332.01

18.5cm



12.0332.02



12.0332.03

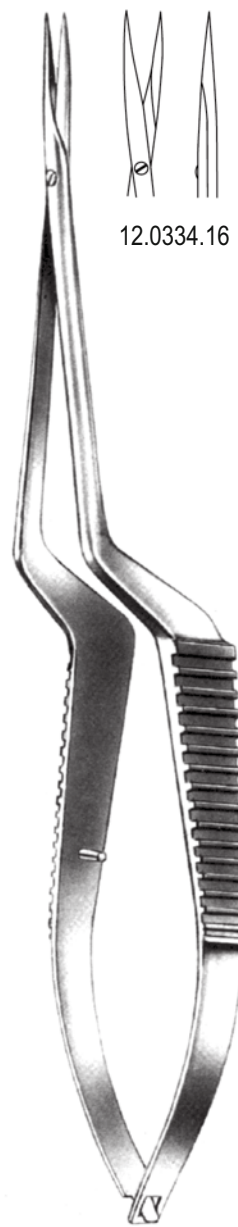

12.0334.16

15.5cm



12.0340.07
7mm



12.0340.10
10mm

DUVAL
14.5cm



12.0344.14
14mm

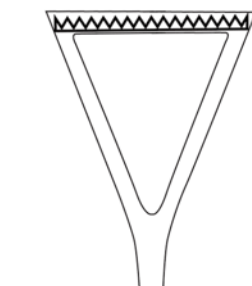

12.0344.27
27mm

COLLIN-DUVAL
20.0cm

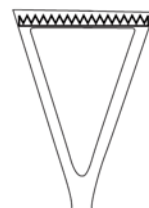

12.0344.18
18mm



HEPP/SCHIEDEL
12.0350.18 18.0cm



SINGLE-TUTTLE
12.0356.23 23.0cm

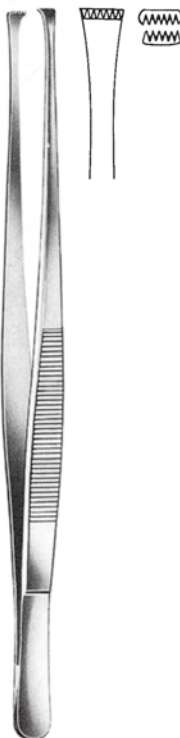

NELSON
12.0360.23 23.0cm



12.0364.21
21.0cm

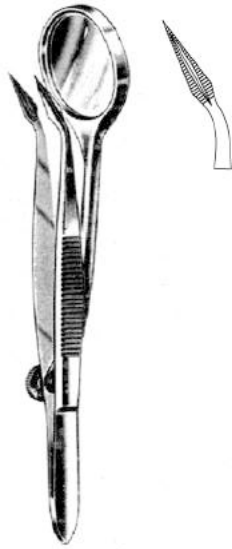

12.0370.12
12.0cm



FEILCHENFELD



12.0376.07
7.5cm



12.0376.09
9.0cm



12.0376.11
11.5cm

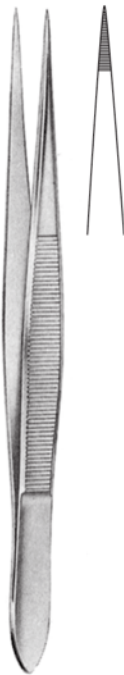

12.0380.12
12.5cm

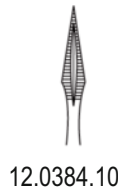

12.0384.10



HUNTER
10.5cm



12.0385.10



12.0390.10



WALTER-CARMALT
10.5cm



12.0391.10



PEET
12.0396.11 11.5cm

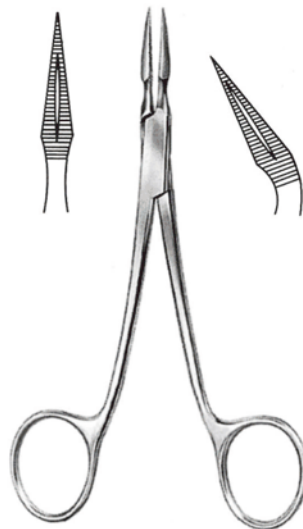

ARTHER
12.0400.14 14.0cm 12.0401.14

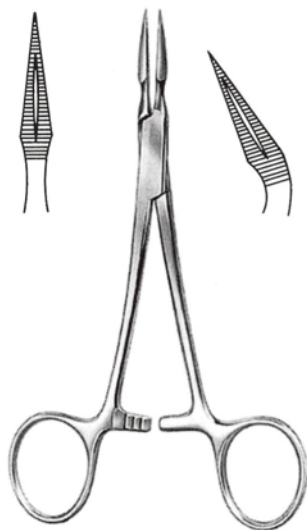

STIEGLITZ
12.0406.13 13.5cm 12.0407.13

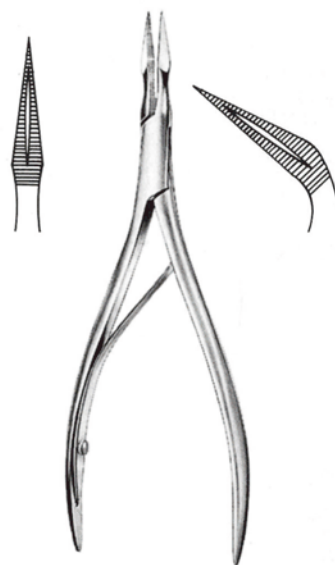

RALK
12.0412.15 15.0cm 12.0413.15

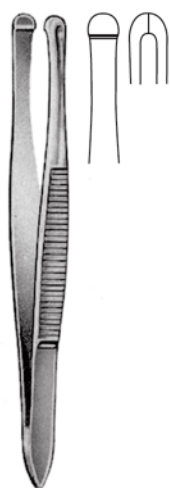

BEER
12.0430.09 9.0cm



LITTAUER
12.0434.08 8.5cm



12.0438.09 9.0cm



DOUGLAS
12.0442.09 9.0cm



DOUGLAS
12.0448.09 9.0cm



BARRAQUER
12.0454.10 10.5cm



GRADLE
12.0460.09 9.5cm



HENRY
12.0466.12 12.0cm